

Arts  
& Lifestyle

ASTRONOMY

Resource Book



Saskatchewan



## 4-H MOTTO

Learn to do by doing.

## 4-H PLEDGE

I pledge  
My HEAD to clearer thinking,  
My HEART to greater loyalty,  
My HANDS to larger service,  
My HEALTH to better living,  
For my club, my community and my country.



## 4-H GRACE

(Tune of Auld Lang Syne)

We thank thee, Lord, for blessings great  
On this, our own fair land.  
Teach us to serve thee joyfully,  
With head, heart, health and hand.

This project was developed through funds provided by the Canadian Agricultural Adaptation Program (CAAP). No portion of this manual may be reproduced without written permission from the Saskatchewan 4-H Council, phone 306-933-7727, email: [info@4-h.sk.ca](mailto:info@4-h.sk.ca).  
Developed: December 2013.

**Writer: Paul Lehmkuhl**



Agriculture and  
Agri-Food Canada

Agriculture et  
Agroalimentaire Canada



AGRICULTURE COUNCIL  
OF SASKATCHEWAN INC.

# Table of Contents

---

## **Introduction**

Overview .....	1
Achievement Requirements for this Project .....	1

## **Chapter 1 – What is Astronomy?**

Astronomy is a Science .....	2
Astronomy vs. Astrology .....	2
Why Learn about Astronomy? .....	3
Understanding the Importance of Light .....	3
Where we are in the Universe .....	5
Looking Back into Time .....	6
Safety and Precautions in Astronomy .....	6

## **Chapter 2 – Using Your Telescope**

Types of Telescopes .....	8
How Telescopes Work .....	10
Tips for Purchasing a Telescope .....	11
Mounting and Tracking .....	13
Understanding the Magnitude Scale for Brightness .....	16
General Guidelines for Using your Telescope .....	17
Weather and Light Pollution .....	18
Binocular Astronomy .....	19

## **Chapter 3 – Tools and Online Links**

Astronomy Apps .....	20
Taking Pictures of Astronomical Objects .....	20
Online Links .....	21

## **Chapter 4 – The Constellations**

What are the Constellations? .....	23
Navigating Around the Sky .....	27
How to Find Some Common Constellations. ....	32

## **Chapter 5 – The Moon**

What is the Moon? .....	40
Phases of the Moon .....	41
Harvest Moon .....	43

Tips for Observing the Moon .....	44
Eclipses .....	45
<b>Chapter 6 – The Solar System</b>	
Getting to Know the Sun and the Planets .....	47
Finding Planets with your Telescope .....	55
Asteroids, Comets, Meteors and Meteorites .....	55
Aurora Borealis .....	58
<b>Chapter 7 – What are Stars?</b>	
How Stars are Born, Live and Die .....	60
Different Types of Stars .....	63
Finding Stars to Observe with your Telescope .....	64
<b>Chapter 8 – What Else is Out There?</b>	
Galaxies .....	67
Star Clusters .....	69
Nebulae .....	71
Finding Galaxies, Star Clusters and Nebulae with your Telescope .....	72
<b>Chapter 9 – Astronomy and Agriculture</b>	
Constellations and Agriculture .....	78
Seasons and the Sun .....	78
Observatories in your Area .....	80
Dark Sky Areas .....	80
Royal Astronomical Society of Canada .....	81
<b>Chapter 10 – Careers in Astronomy</b>	
How to Become an Astronomer .....	82
What do Astronomers do? .....	83
<b>Glossary of Definitions</b> .....	86

# Introduction

---

## Overview

Have you ever looked up at the night sky and wondered what's out there? Have you ever asked yourself "What are the stars and planets made of? Where do stars come from?" "What are the constellations and how do I find them?" "Why does the Moon go through phases?" "Are there planets out there beyond the Earth that contain life?" These are only a few of the questions that astronomy digs into. If you find these questions interesting then this 4-H Project is for you! This reference book will guide you through the science of astronomy and by the end you will be able to navigate around the sky; you'll know how to use a telescope; and you'll have a strong understanding of the characteristics of various objects that are out there in our universe.

## Achievement Requirements for this Project

- A completed record book
- Complete at least two discussion activities
- Complete at least two research activities
- Complete at least two concept activities
- Complete at least two build activities
- Complete at least two navigation observation sheets
- Complete at least two solar system observation sheets
- Complete at least two star observation sheets
- Complete at least two deep sky object observation sheets

# Chapter 1 What is Astronomy?

---

## Astronomy is a Science

For thousands of years people have looked up at the night sky and wondered what is out there. Ancient civilizations from all over the world recognized that the universe is structured, ordered and that there are regular patterns that occur. We can attribute our current understanding of the universe to the ancient Greeks who laid the foundation for the science of astronomy. Greek philosophers realized that we could understand the patterns in the universe by using logic, reason and mathematics. A simple example of a regular pattern in the world is the seasons. The seasons change throughout the year from winter to spring to summer to fall and back to winter. We will see in a later chapter that the seasons change due to the tilt of the Earth as it orbits around the Sun. If we recognize a pattern in the universe, then we can try to figure out why it happens. This process of figuring out why something happens in the world is called the scientific method. The science of astronomy makes use of the scientific method to explain how the universe works.

## Astronomy vs. Astrology

Without having a background in astronomy it is easy to confuse astronomy with astrology. Astronomy is a rigorous science that follows the scientific method. Some questions that an astronomer might ask are:

- Where did the Earth, planets and stars come from?
- What is happening on the other planets?
- What is going on inside the Sun?
- What happens when a star dies?
- What is light?
- What is space and time?
- Why does the moon go through phases?
- Why do the seasons occur?
- What is the difference between a meteor, a meteorite, an asteroid and a comet?
- Is there life on other planets beyond the Earth?
- How big is the universe and is there an edge?
- How old is the universe?

In other words, astronomy studies the universe on a large scale. Astronomers are interested in what is going on out there in the universe and they apply the scientific method to find these things out.

Astrology, on the other hand is not grounded in the scientific method. Astrology also assumes that there is a connection between astronomical events and the human world. For example, an astrologer might claim that a particular configuration of the planets would allow her to predict the future. This makes the assumption that there is some connection between planetary configurations and human beings. In the science of astronomy, there is no evidence to support that there is any connection between the planets and what goes on in the lives of human beings.

## Why Learn about Astronomy?

Astronomy can make you feel connected to the universe in a deep way. By studying the night sky we begin to understand where we came from and our place within the universe. We often get caught up in everyday life and we neglect the big picture. When you study astronomy it takes you on a trip beyond the Earth, beyond the solar system and even beyond our galaxy.

## Understanding the Importance of Light

Light is one of the most important aspects of astronomy. Everything that we can see in the night sky, whether it is a star, a planet or a galaxy, emits light. If an object did not emit light then we would not know it was there. Objects such as stars, galaxies and nebulae generate their own light whereas planets and the moon reflect sunlight and do not create their own light.

Human eyes are capable of seeing only a tiny fraction of the entire light spectrum. Light is not just what we can see; the light spectrum also includes microwaves, radio waves, infrared light, x-rays and gamma rays. The difference between visible light and x-rays for example is that x-rays are oscillating at a much higher frequency and they have a smaller wavelength than visible light. Radio waves on the other hand have a much longer wavelength and smaller frequency than visible light. The human eye can only see in visible wavelengths but we have developed the technology that has allowed us to see and use light from other parts of the spectrum. For example, we use radio waves for FM and AM radio. We use x-rays for checking for cavities when we visit the dentist, and we use microwaves for heating up food. Using certain technology, astronomers are able to see in other wavelengths besides the visible part of the spectrum.

The following diagram shows the light spectrum and the relative sizes of the different wavelengths of light:

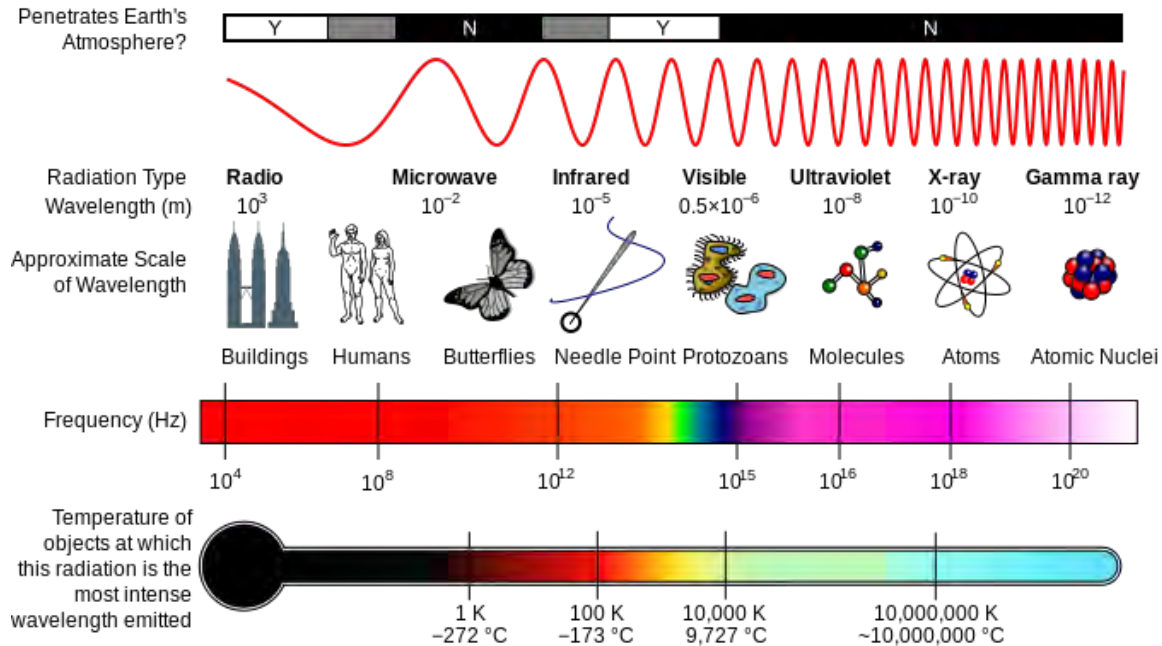

Light spectrum with relative sizes of wavelengths, Wikipedia, Inductiveload, NASA, 2007

### What is Light-Speed?

Light travels at the staggering speed of 300,000 kilometres per second. To put this into perspective, light could travel seven and a half times around the Earth in just one second. When you turn on a lamp the light seems to hit your eye instantly. In reality, the light is travelling extremely fast to hit your eyeball so it only appears to turn on in no time at all. The distance between your eye and a light bulb is very small so the light hits your eye within a tiny fraction of a second.

### What is a Light Year?

The universe is so big that Astronomers talk about light years when describing the distance to stars, galaxies and other far away objects. A light year is the distance that light can travel in one year. If we want to find out the distance of a light year in kilometres we would need to multiply the speed of light by the number of seconds in one year. Think about it this way, if you are driving in a car at 100km/hr and you want to know how far you have gone in two hours, you would just multiply your speed by the length of time that you were driving at that speed. 100km/hr multiplied by two hours gives 200km, so in two hours you would have travelled 200km.

So what is the distance that light travels in one year? As we saw before, light travels at 300,000 kilometres per second. What we need to find out is how many seconds there are in a year and then multiply that by the speed of light. There are 365 days in a year, each day has 24 hours, each hour has 60 minutes and each minute has 60 seconds. So that means there are  $365 \times 24 \times$



$60 \times 60 = 31,536,000$  seconds in a year. Now multiply the speed of light by the number of seconds in a year and we get:

300,000 kilometers per hour  $\times$  31,536,000 seconds = 9,460,800,000,000 kilometers.

That means that one light-year is equal to just under 10 trillion kilometres.

The sun is eight light minutes away from the Earth, meaning that it takes 8 eight minutes for light to travel from the Sun to the Earth. If the sun were to suddenly explode, we would not know about it for eight minutes because it would take the light from the explosion that long to get here!

## Where we are in the Universe

The universe is big... really big. To get us started in understanding where we are in the universe first consider this question: What is the closest star to us? If you answered the sun then you are correct. Sometimes people forget that the sun is in fact a star. Moving out from the sun there are the eight planets: Mercury, Venus, Earth, Mars, Jupiter, Saturn, Uranus and Neptune. The next closest star to the Earth is one called Proxima Centauri, located 4.2 light years away, meaning that if you could travel at light speed then it would still take 4.2 years to get there from the Earth. To find out the distance between the Earth and Proxima Centauri in kilometres we would take the distance of 1 light-year (10 trillion kilometres) and multiply this by 4.2, giving us roughly 40 trillion kilometres!

The Milky Way galaxy contains billions of stars beyond the sun. If you are in an area that is very dark, away from city lights, you can easily see the Milky Way with your naked eye. It looks like a thick band of stars running from one end of the horizon to the other.

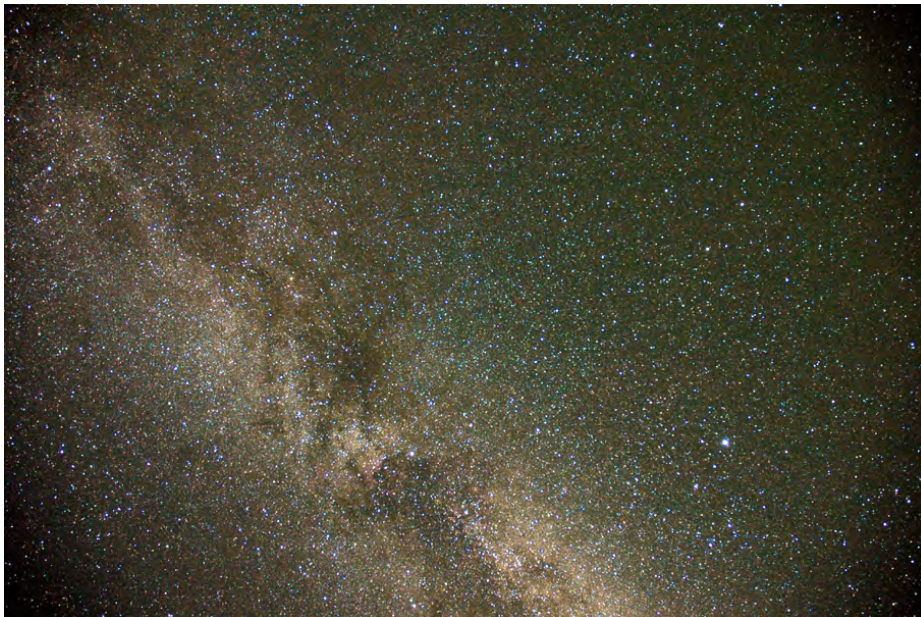

Beyond the Milky Way galaxy there are, you guessed it, billions of other galaxies spanning the whole universe. Each galaxy contains billions of stars all gravitationally attracted to one another. The nearest galaxy to us is one called the Andromeda Galaxy. Even though it is the closest to us, it is still 2.5 million light years away. That means that if you could travel at the speed of light, it would take you 2.5 million years to get there from the Earth! Surprisingly, the Andromeda Galaxy is an object that you can actually see with your naked eye on a dark, moonless night. In a later chapter we will see how you can navigate around the sky to find it.

## Looking Back into Time

Astronomy might be the only science where you actually get to experience time travel. As we saw before, light travels at the staggering speed of 300,000 kilometres per second. In everyday life we do not notice the time that it takes light to get to our eyes because in everyday life we deal with relatively small distances. In Astronomy the effects of light speed become more obvious because anything we look at is so far away. For example, we know that the sun is eight light minutes away from the Earth, which means that you are seeing the sun as it was eight minutes ago, since it has taken light that long to reach your eye. You will never see the sun right now because the light from the sun has taken eight minutes to travel through space from the sun to your eye. Let us take this idea further. If you look at Proxima Centauri, the next closest star to the Earth, it is 4.2 light years away. When you look at Proxima Centauri you are seeing it as it was 4.2 years ago because it has taken light that long to reach your eye. Let us go even further. The Andromeda Galaxy as we saw is 2.5 million light years away, which is the nearest galaxy to our own. If you look at the Andromeda Galaxy you are seeing it as it was 2.5 million years ago because it has taken light that long to reach your eye as it travelled through space!

## Safety and Precautions in Astronomy

Here are some tips on how to stay safe and be prepared when completing this project:

- Think about your goals.
- Plan your night of observing.
- Ensure that an adult is with you when you venture out to observe the sky.
- Be prepared – Make a checklist of the things that you will need to take with you when you are observing. Examples are flashlight (with a red light bulb), pencil, eraser, binoculars, telescope accessories.
- Try to find a dark, safe place away from light pollution for observing.
- Watch your step in the dark.

- Bring a flashlight with you to make sure you can see where you are going in the dark (most astronomers use a flashlight with a red light bulb because your eyes will more easily adjust to the darkness).
- Never look directly at the sun and never point a telescope or binoculars at the sun!
- Dress warm! Even if it seems warm out, the temperature can drop quickly at night time so be aware that you should always dress warmer than you think is necessary. Especially if you live in an area where the temperature drops far below zero, make sure that you bundle up.
- Be safe online! If you are ever doing online research, or visiting chat rooms and blogs, never share any personal information. Be sure to tell your parent or guardian if you ever feel unsafe or uncomfortable online.

# Chapter 2 Using Your Telescope

---

## Types of Telescopes

There are two types of telescopes, refracting telescopes and reflecting telescopes. Refracting telescopes use glass lenses whereas, reflecting telescopes use mirrors rather than lenses.

### Refracting Telescopes

A refracting telescope contains two lenses, an objective lens and an eyepiece lens. The objective lens is found near the end of the telescope tube and is responsible for gathering and focusing the incoming light from a star, planet or other object. The lens in the eyepiece then takes all that collected light and magnifies the image before it enters your eye.

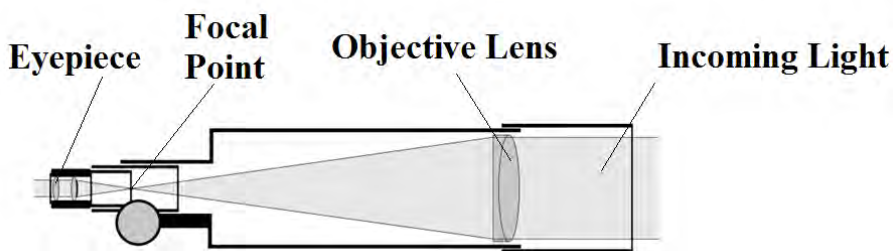

*Refracting telescope cross section, WikiCommons, MesserWoland, 2006*



*Celestron Refracting Telescope, WikiCommons, fractal.scatter, 2009*



## Reflecting Telescopes

In a refracting telescope the light passes through two lenses before it hits your eye. A reflecting telescope, on the other hand contains two mirrors that reflect the light within the tube. The light is directed to the lens in the eyepiece where the image is magnified before it enters your eye. There are two main types of reflecting telescopes, Newtonian and Cassegrain.

A Newtonian Reflecting Telescope has a curved primary mirror at the base of the telescope tube and the light is reflected to a flat secondary mirror further up the tube. The flat mirror is on an angle, which redirects the light into the eyepiece. The eyepiece is conveniently mounted on the side of the telescope that you can look through to see a magnified image.

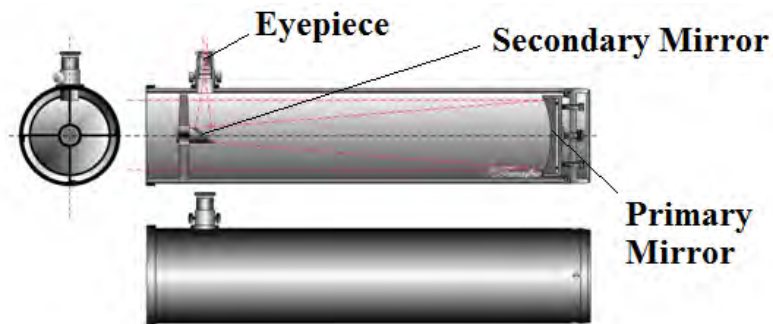

*Newtonian reflector cross sections (dotted line is incoming light), Wikipedia, Tamasflex, 2009*

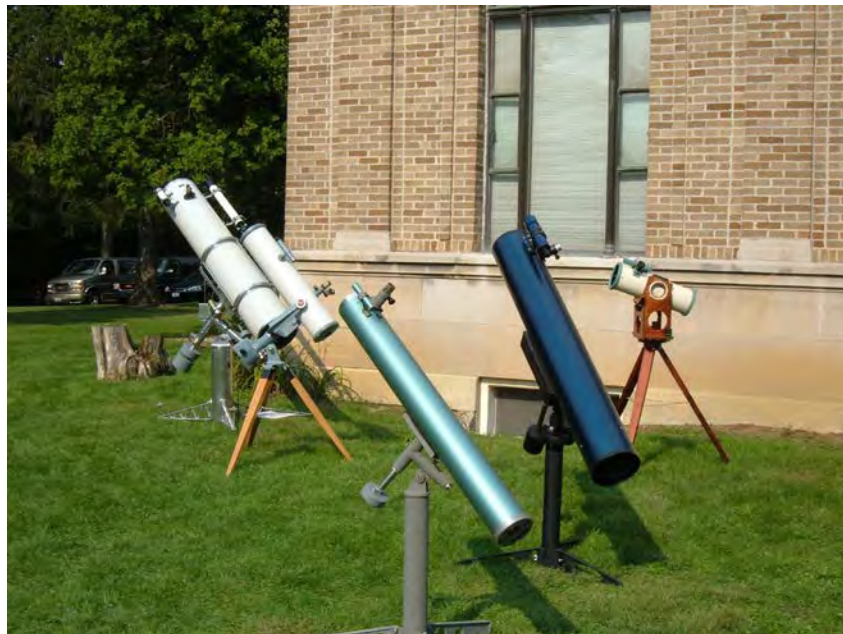

*Newtonian telescopes, WikiCommons, Analogue Kid, 2006*

A Cassegrain reflecting telescope has a curved primary mirror at the base of the telescope and the light is reflected to a flat secondary mirror further up the tube. The light is then reflected back to the base of the tube through a slit in the primary mirror. The eyepiece is mounted at the base of the telescope that you can look through to see a magnified image.

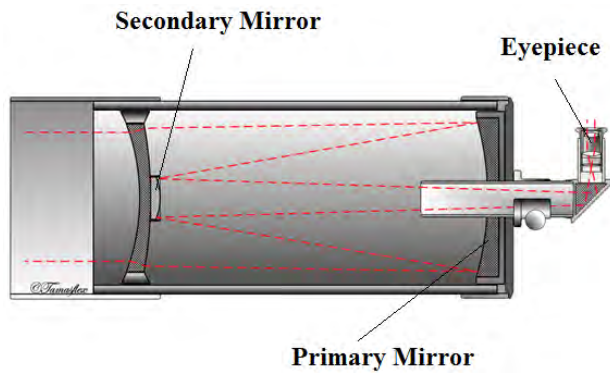

Cassegrain reflector cross section (red dotted line is incoming light),  
 WikiCommons, Tamasflex



Celestron Cassegrain reflector, WikiCommons, Staycoolandbegood, 2005

## How Telescopes Work

All telescopes have one thing in common; they make faraway objects look closer. To understand how a telescope does this, first think about your eye. The pupil is the part of your eye that lets a certain amount of light in. The lens is located behind the pupil and is responsible for focusing the light onto the retina.

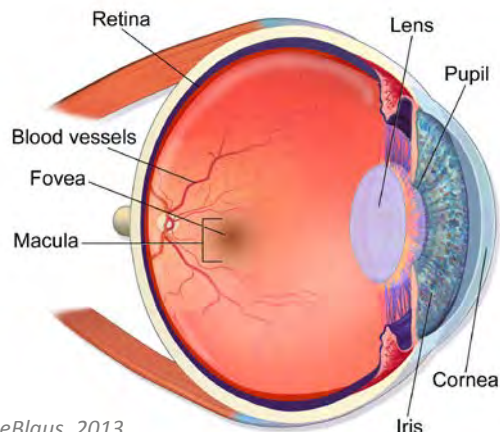

WikiCommons, BruceBlas, 2013

Eye Anatomy

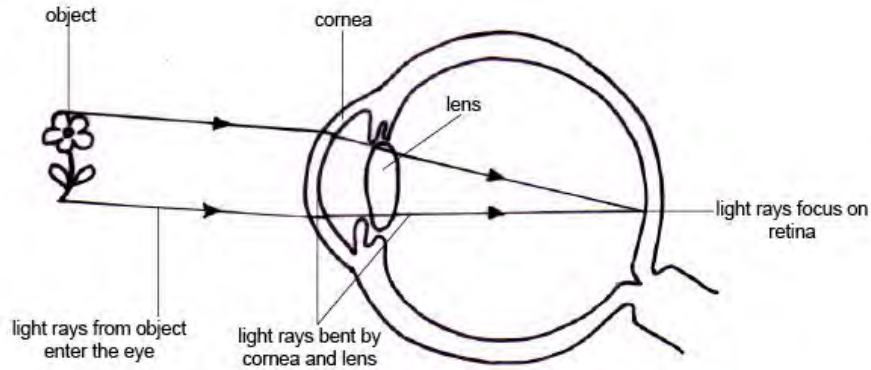

*Light entering eye with lens focusing light onto retina, WikiCommons, Ruth Lawson, 2007*

Your eye and a telescope are actually quite similar; they both let a certain amount of light in and they also focus the light. Think about a refracting telescope. The primary lens of a refracting telescope lets a certain amount of light go through and it also focuses the light. A telescope lens is much bigger than your pupil so a telescope can gather much more light compared to your eye. When you look through a telescope, all that light that is collected is directed into your eye. Essentially, a telescope makes your eye as big as the lens so you can see things that are very far away.

The strength of a telescope depends on how much light it can collect. A telescope with a bigger objective lens or primary mirror will have more light gathering power than a telescope with a smaller lens or mirror. This is very important to think about when you are considering purchasing a telescope.

## Tips for Purchasing a Telescope

If you are considering buying a telescope there are a few things to keep in mind before making a purchase.

### Magnification is not the Most Important Part

Some department stores and camera shops may advertise that their telescopes have very high magnification power. Keep in mind that magnification is the least important part of getting a bright, well-resolved image out of your telescope. If you want to make the image bigger or smaller, all you need to do is change the eyepiece. Many telescope kits come with different eyepieces, or you can purchase them in addition to your telescope if you want to have the option of changing the magnification.

### Look for Light Gathering Power

A primary aspect that you should look for in a telescope is light gathering power. In other words, better telescopes have a greater ability to collect light. Telescopes that have bigger objective

lenses or primary mirrors have a greater ability to collect light; we call this the aperture of the telescope. If you find a telescope that you like, be sure to look closely at the telescope specifications on the package or ask an attendant for more details about the telescope. The aperture of a telescope will tell you how much light gathering power a telescope has.

### **Refractor or Reflector?**

Both refracting telescopes and reflecting telescopes have advantages and disadvantages. It comes down to personal preference for what type of telescope you should get. Generally, larger refracting telescopes will be more expensive than reflecting telescopes with the same aperture. Unless you are doing some very detailed observing, you will not see a big difference when you look through a refracting or a reflecting telescope. The nice thing about reflecting telescopes is that they are pretty compact since the light is reflected within the tube before it hits the eyepiece. Refracting telescopes on the other hand are generally not as compact as reflectors because they have to be longer than the focal length of the objective lens.

### **Used Telescopes**

It is a great idea to consider buying a used telescope rather than a new one because it can save you hundreds of dollars. Many used telescopes that you can find online are as good as new so you can often find a quality telescope at a much cheaper price than buying new. Some websites to check out for used telescopes and other astronomical equipment in Canada are:

- [www.astrobuyandsell.ca](http://www.astrobuyandsell.ca)
- [www.astromart.com](http://www.astromart.com)
- [www.kijiji.ca](http://www.kijiji.ca)
- [www.ebay.ca](http://www.ebay.ca)
- [www.amazon.ca](http://www.amazon.ca)

### **Be Realistic**

It's important to understand that when you look through a telescope, it is not going to look like some astronomy photographs that you see in calendars, online or on television. Pictures like that were taken with long-exposure imaging techniques using very high-powered cameras and telescopes. When you look through a telescope, the image will be black and white, and sometimes you will see some colour, depending on the object you are looking at.

Take a look at the difference between the two following pictures of the Orion Nebula. The picture on the left was taken by an amateur astronomer who took the time process the image to give it colour. The image on the right is similar to what you would see as you look through a modestly powered telescope.





Processed image of the Orion Nebula courtesy of Tenho Tuomi



Orion Nebula courtesy of Jeff Swick

## Mounting and Tracking

Telescopes can be pretty heavy and awkward so if you buy a telescope it is important to consider also buying a telescope mount. There are two basic types of telescope mounts, altazimuth and equatorial. Whenever you point your telescope to an object in the sky, you need to keep in mind that the Earth is rotating, and so within minutes, the object you are looking at may have moved out of the field of view. Some telescope mounts come with a tracking motor that allows the telescope to stay fixed on any object you point the telescope to. Tracking drives are more common on equatorial mounts than altazimuth mounts. Let us take a look at these two types of mounts in more detail.

### Altazimuth Mount

Altazimuth is short for altitude-azimuth mount. The altitude is how high an object is above the horizon and the azimuth is where along the horizon you are looking.

*Altitude and Azimuth coordinates,  
WikiCommons, TWCarlson, 2012*

An altazimuth mount allows the telescope to rotate in a circle around the base (along the azimuth) and up and down along the altitude. You can think of the base of

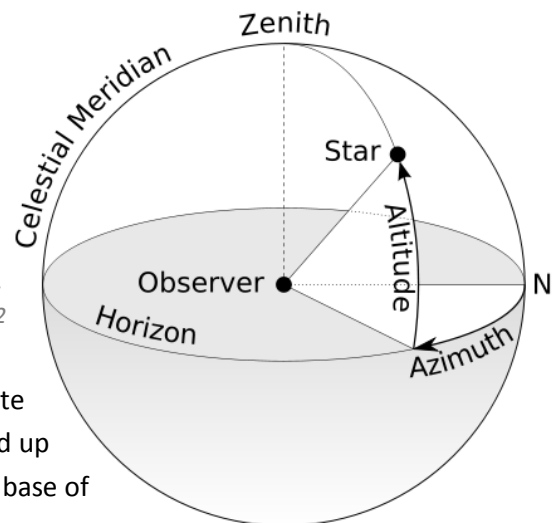

an altazimuth mount as a compass bearing in that you can point the telescope in any direction whether it's north, east, south or west. Then, you can pan the telescope up and down across the sky which allows you to see any part of the sky while facing a particular direction. The primary advantage to altazimuth mounts is their simplicity. The disadvantage is that tracking motors are usually not suited for altazimuth mounts.



*Newtonian reflector and Altazimuth mount, Wikipedia, ECeDEE, 2005*

## Equatorial Mount

Before we talk about an equatorial mount, we should first look at astronomical coordinates called right ascension and declination. Right ascension (RA) and declination (Dec.) are coordinates that tell you where astronomical objects are found in the sky. Stand up and point your hand out directly in front of you, now start rotating your body slowly in a circle. As you do this you are moving in right ascension (similar to longitude). Now stop rotating, keep your arm pointed out in front of you and move it slowly up toward the ceiling. You are now moving your arm in declination (similar to latitude).

Like coordinates on the Earth that tell you where certain cities or countries are located, RA and Dec. are used to tell you where objects like stars, galaxies and other deep sky objects are located. An equatorial mount allows the telescope to move in two directions, left and right around a circle (which corresponds to the right ascension) and up and down (which corresponds to declination).

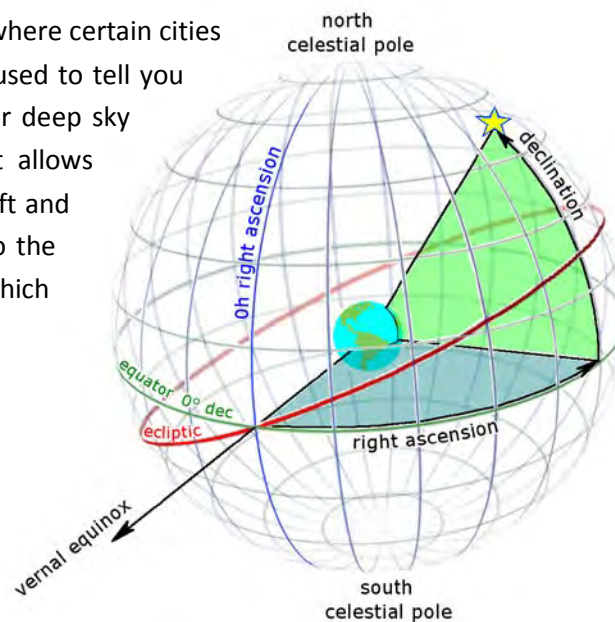

*RA and Dec. coordinates, Wikipedia, Tfr000, 2012*

With an equatorial mount, the telescope is set up such that the right ascension wheel is parallel with the Earth's rotation axis. At the same time the telescope is free to move in a circle along the same direction that the Earth is rotating. Equatorial mounts are convenient because it is possible to use a clock drive to rotate the telescope at the same rate that the Earth is rotating and in the opposite direction. This cancels out the rotation of the Earth and so any object you point the telescope to will stay fixed on that object.

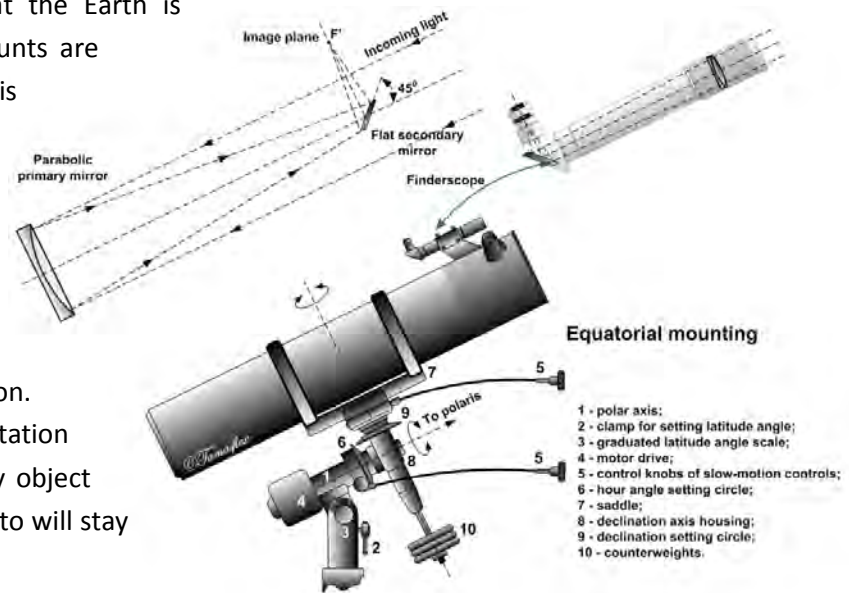

*Newtonian reflector with equatorial mount, Wikipedia, Tamasflex, 2009*



Some telescopes have the coordinates of various astronomical objects programmed within them. These telescopes have a keypad with a "GoTo" function that allows you to select the object you want to look at and the telescope will automatically point to that object - you just have to make sure that your telescope is calibrated at the start of your observing night. Most telescopes come with instructions that show you how to calibrate your telescope.

*Cassegrain telescope with equatorial Mount and GoTo, WikiCommons, Kapege.de, 2009*

## Understanding the Magnitude Scale for Brightness

Astronomers have created a scale that tells you how bright a star is relative to other stars. The scale runs from negative numbers to positive numbers. It may seem backwards but a more negative number means that the object is brighter. For example, the sun is the brightest object in the sky and has a visual magnitude of -27.6. The full moon has a visual magnitude of -13. The moon has a less negative number because it is not as bright as the sun. Vega, a relatively bright star in the constellation Lyra has a visual magnitude of 0. For dimmer objects, we start to move into the positive numbers. The visual magnitude of Mars is 1.8, a positive number, which means that Mars is dimmer than Vega. Assuming perfect weather conditions and no light pollution, the dimmest that an average person can see with their naked eye is magnitude 6. Uranus has a magnitude of 5.3, so the average person would just barely be able to make out this planet with their naked eye.

Any object with a magnitude greater than 6 will require the use of binoculars or a telescope to see. Keep this in mind as you read through this reference book because then you will have an idea of what objects you will be able to see with your naked eye and what objects you will need to use binoculars or a telescope to see.



# General Guidelines for Using your Telescope

## Parts of a Telescope

The parts of a telescope are shown in the diagram below. It may be helpful to familiarize yourself with these parts before you read on:

## Steps to Using your Telescope

This section will outline some general steps in using your telescope when locating objects. This list is not comprehensive and there may be additional steps to consider depending on what you are observing and your specific telescope and mount.

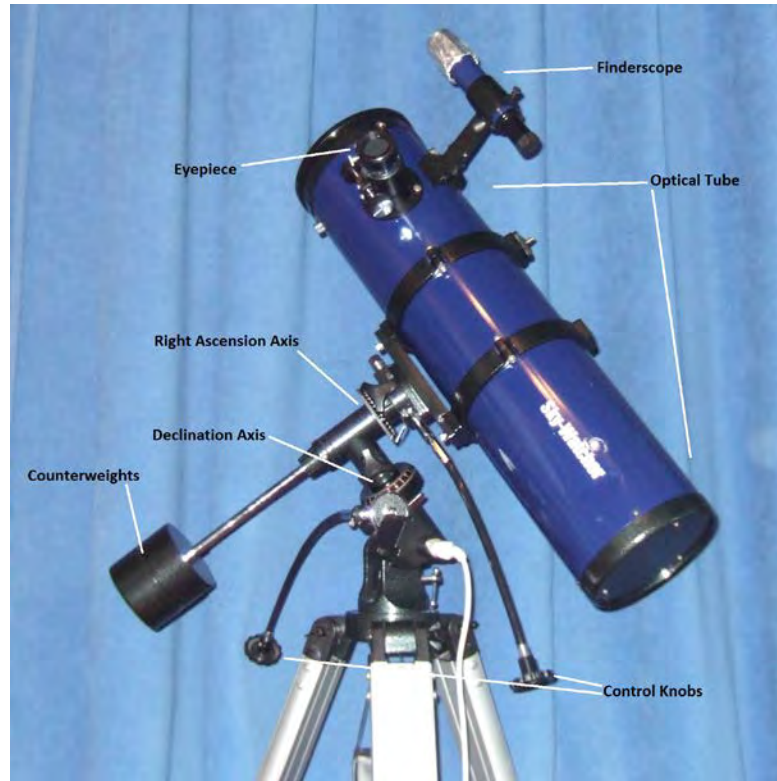

*Newtonian reflector telescope with equatorial mount,  
WikiCommons, Roqilbert, 2007*

1. Pick an object that you want to observe.
2. Ensure that the magnitude is reasonable (probably not dimmer than magnitude 10).
3. Ensure that the object is visible at that time of year (see Seasonal vs. Circumpolar constellations).
4. Calibrate Finderscope (or TELRAD) – this means that the finderscope or TELRAD needs to be lined up parallel with the telescope tube so that when you look through the finder you will see the same part of the sky when you look through the eyepiece – your telescope should come with instructions for how to perform this calibration (if not you can also look online).
5. Find a clear and dark place to go with your telescope.
6. Locate the constellation that the object is found in.
7. Find a star that is near the object that you wish to observe (if the object you wish to observe is a star then you can skip this step).
8. Line up your Finderscope or TELRAD with the star and ensure that you can see it in the eyepiece of your telescope

9. Make fine movements of your telescope to move it to the location of the object (some telescopes have fine adjustment knobs that you can use).
10. You should see the object within the eyepiece (if not, you can continue to make fine adjustments until you see it).

## Weather and Light Pollution

There are two big factors that will make or break your night of observing: bad weather and light pollution. If the sky is too cloudy or hazy then it will really impact what you are capable of seeing during your night of observing. It is important to check the forecast before you head out with your telescope at night to be sure that the weather will cooperate. In the next section you will find links to some weather websites that are great for astronomers to use.

The other factor that you will need to consider when observing the sky is light pollution. Light pollution makes it really hard for astronomers to see objects clearly when they look through their telescopes. Examples of light pollution are streetlights, car lights, house lights, stadium lights and even moonlight.

All of these sources of light can make for poor viewing conditions. The best place to be when observing the sky is far away from any sources of light. You want to be in as dark a place as possible. People that live on farms or acreages are fortunate because there tends to be less light pollution in rural areas. In many areas away from the city you can see the vastness of the Milky Way Galaxy spanning from one end of the horizon to the other. If you live in the city, you might be surprised how many more stars you can see when you get far away from city lights. The image to the right shows you a comparison between a night sky without light pollution (above) and a night sky with light pollution from a city (below).

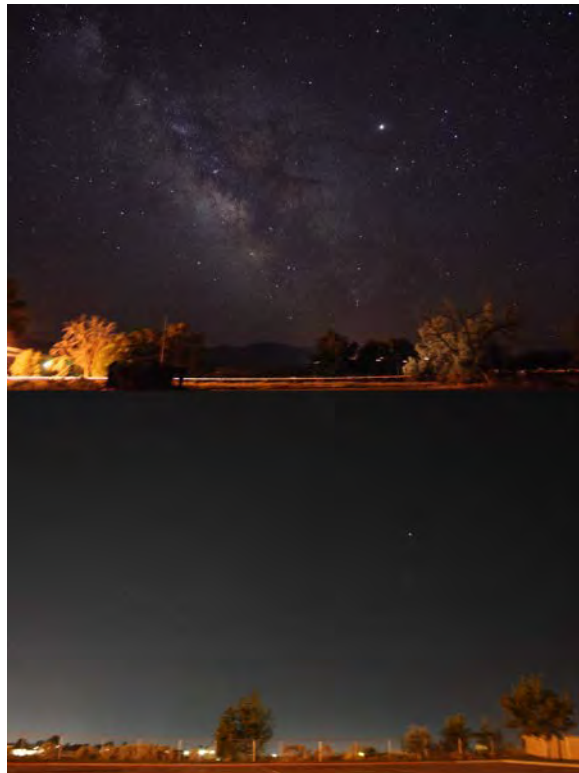

*Wikipedia, Jeremy Stanley, 2007*

## Binocular Astronomy

Before you invest in a new or used telescope you may want to try finding some celestial objects with a pair of binoculars. You might be surprised to find out how much you can see with just a pair of binoculars that you have lying around the house. Depending on the power of your binoculars and your viewing conditions, you should be able to see many objects brighter than magnitude eight.

## Chapter 3 Tools and Online Links

---

### Astronomy Apps

If you have a Smartphone, iPod, iPad, tablet or similar device there are some powerful apps that are very useful for navigating around the sky and locating objects. In fact, most of the apps will track your GPS coordinates and if you hold your phone up to any direction in the sky, it will show you what constellation you are looking at or what planets or other objects are up in the sky. Also, many of the apps out there will overlay the mythological image overtop of the pattern you will see in the sky. This is a great way to quickly and efficiently learn where the constellations are located and to learn their mythology. Here is a list of apps that are available for purchase or download for either Apple or Android products:

Astronomy Apps	Compatible with
Star Walk	Apple products
SkySafari	Apple or Android products
SpaceMap	Apple products
Planets	Apple or Android products
Astronomy Picture of the Day	Apple or Android products
Google Sky Map	Android products
Star Chart	Android products
Star3Map	Android products

### Taking Pictures of Astronomical Objects

#### Digital Cameras

If you are interested in taking pictures of astronomical objects then you may want to consider purchasing a digital camera that can mount to your telescope. Most telescope cameras are mounted where you would normally put the eyepiece. Digital telescope cameras will range in price from \$150-\$1,000 depending on the quality of the camera. It is possible to take a picture by holding a point and shoot camera up to the eyepiece of your telescope, however this is not



recommended since it is difficult to get a quality image and you risk scratching the lens of the eyepiece or your camera.

### **CCD Cameras**

Have you ever wondered how they get such amazing pictures of astronomical objects that you see in calendars, online or on television? These images are professionally processed and often high powered telescopes and cameras are used. Taking images like these yourself is not impossible, as long as you have the right equipment. A charge coupled device (CCD) camera is a special type of camera that mounts on your telescope where the eyepiece would normally be placed. A CCD camera is extremely sensitive to light and it is capable of taking long exposure pictures. CCD cameras are not cheap however; they usually will cost over \$2,000 if you buy one new.

### **Online Links**

There are many online resources that you can check out whether you are a beginner or seasoned astronomer. There are many websites, blogs and applets to check out that give great details on news, current events, constellation mythology, how to find certain objects in the sky, how to take pictures of astronomical objects, or you can just look at some incredible images that were taken with high-powered telescopes. There is even a website dedicated to creating an online network to search for extraterrestrial life. Below is a list of links with a description for what you can find at each one. Also included in this list are some websites for checking the weather before you go out observing.

Website	What It's About
<a href="http://www.earthsky.org">http://www.earthsky.org</a>	Science news, articles and updates on astronomical events. You can also find updates to what planets will be visible throughout the year.
<a href="http://www.kidsastronomy.com/">http://www.kidsastronomy.com/</a>	Learn more about astronomy through games and online activities.
<a href="http://www.space.com/">http://www.space.com/</a>	Great website for news, current events, research and pictures. There is also a link that is updated regularly with tips for sky watching.
<a href="http://www.rasc.ca/">http://www.rasc.ca/</a>	The Royal Astronomical Society of Canada – get involved with your local chapter to receive updates on current events in your area. This is a great place for beginner and amateur astronomers to connect within their community. There is an “Ask an Astronomer” link where you can contact an RASC member to get answers to your astronomy related questions.
<a href="http://hubblesite.org/">http://hubblesite.org/</a>	Amazing images taken with the Hubble Space Telescope; also find some great information and news related to astronomy.
<a href="http://www.nasa.gov/">http://www.nasa.gov/</a>	Find information, news, apps, interactive links and more.
<a href="http://seti.org/">http://seti.org/</a>	Information, news and research dedicated to the “Search for Extraterrestrial Intelligence”.
<a href="http://setiathome.berkeley.edu/">http://setiathome.berkeley.edu/</a>	Participate in the search for extraterrestrial life on your own computer by downloading a program that analyzes radio signal data.
<a href="http://asc-csa.gc.ca/eng">http://asc-csa.gc.ca/eng</a>	Updates on what's going on at the Canadian Space Agency.
<a href="http://www.skynews.ca/">http://www.skynews.ca/</a>	Canadian magazine dedicated to astronomy and stargazing.
<a href="http://google.com/sky/">http://google.com/sky/</a>	Linked to Google Earth, Google Sky is an interactive viewer that allows the user to navigate around the sky and locate objects.
<b>Weather websites</b>	
<a href="http://weather.gc.ca/">http://weather.gc.ca/</a>	Government of Canada weather website.
<a href="http://cleardarksky.com/csk/">http://cleardarksky.com/csk/</a>	A weather website dedicated to astronomers providing very detailed weather information.

# Chapter 4 The Constellations

## What are the Constellations?

The constellations are patterns of stars in the sky connected by imaginary lines. People have used the constellations for thousands of years in navigating the Seas, knowing when to plant crops and even to tell time. For many civilizations they hold a mythological significance and the constellations tell a story. In these star patterns people have imagined animals, heroic figures, gods and even monsters. All the constellations are like a map in the sky.

Astronomers use the constellations to navigate around the night sky in order to find stars and other interesting objects like galaxies and nebulae. For example, the constellation Ursa Major in Greek Mythology is the Great Bear and looks like this:



Wikipedia, Till Credner, 2004

You can see that this pattern of stars in the sky makes out the shape of a bear. You might recognize this constellation as the Big Dipper, however, the Big Dipper is actually just a small portion of the larger constellation of Ursa Major. The Big Dipper portion makes up just the tail and the rear end of the Great Bear, as seen in the following picture.

### Constellations in the Northern Hemisphere

The imaginary line that splits the Earth in half is called the equator. The equator cuts the Earth into two equal halves called hemispheres. Here in Canada we live in the northern part of the world and so we call this half of the Earth the northern hemisphere. In the northern hemisphere

we can see a collection of constellations that are different than the constellations they can see in the southern hemisphere. This is because in the northern hemisphere we are looking out into a different part of space than they are in the southern hemisphere. In this reference book we will focus on the constellations that are visible in the northern hemisphere.

### Seasonal Constellations vs. Circumpolar Constellations

Consider this question: Why does the sun rise and set? The answer is that the Earth is rotating. The Earth completes one rotation in 24 hours so during that time one half of the Earth will be daytime and the other half will be night time. The Earth is rotating on an imaginary axis that runs through the North Pole and out the South Pole and is tilted by 23.5 degrees with respect to Earth's orbit.

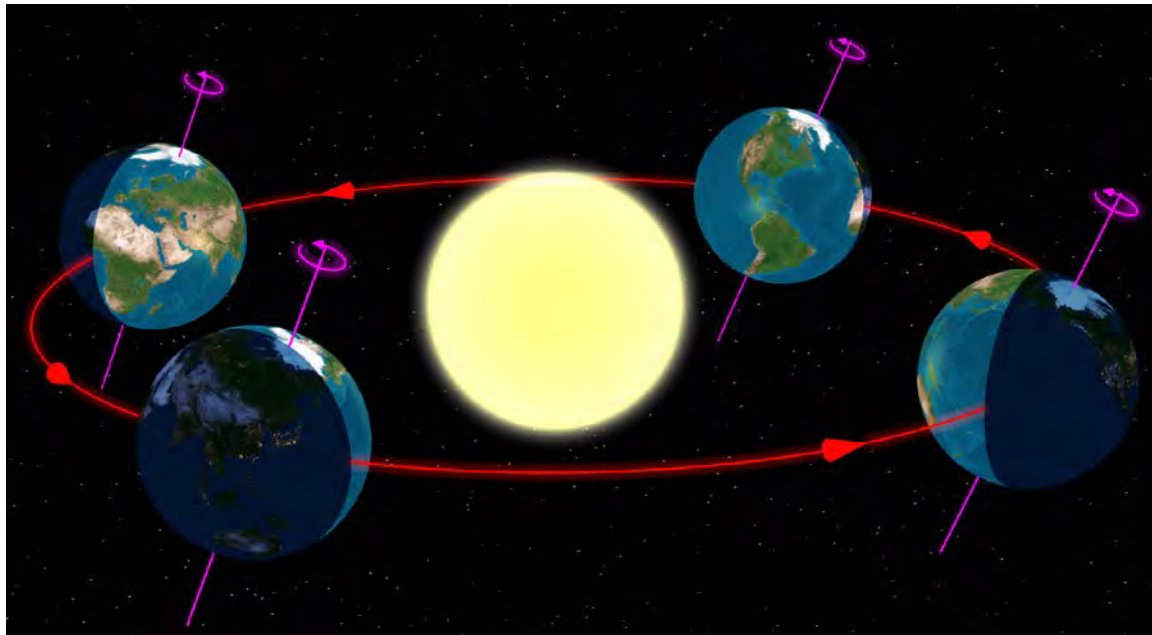

*Earth tilted on its axis as it orbits the sun, Wikipedia, Tau'olunga, 2006*

As the Earth rotates on its axis, the sun appears to move across the sky from sunrise to sunset. In reality it is just the Earth that is rotating which makes the sun appear to move across the sky. The moon, planets and constellations will also rise and set as the Earth rotates.

The long exposure image to the right shows star trails as a result of Earth's rotation. At the centre of the image is the North Star, the star in which the rotation axis of the Earth points toward.

The Earth is rotating on its axis but it is also orbiting around the sun. The Earth takes 365.25 days for one complete orbit around the sun. As the Earth orbits the sun, we can see different constellations throughout the year. Have you ever wondered why you can see the Orion constellation in the winter, but not in the summer? Or why you can see the Big Dipper year round when other constellations tend to disappear? The answer is that some constellations are seasonal (they are visible for part of the year and they set for the other part of the year) and other constellations are circumpolar (they are visible in the sky year round).



*Star trails with North Star at the centre,  
Wikipedia, Kevin Hadley, 2012*

Let's look at an example of seasonal vs. circumpolar constellations. If you were to look at the constellation Orion from Saskatoon at 11 p.m. on December 2, 24 hours later Orion would appear in roughly the same place in the sky because the Earth would have gone through one complete rotation. If you were to look at the same spot in the sky on June 2, Orion would no longer be in that part of the sky since it would have set below the horizon. Orion, like all the constellations, is very slowly creeping across the sky as the Earth orbits the sun. For this reason, Orion is considered to be a seasonal constellation. Orion will set below the horizon in the summer months and it will rise to be visible in the winter months. The Big Dipper, on the other hand, is visible year round. You may notice that the Big Dipper changes its position in the sky, for example it might flip upside down in the wintertime, but you will never see the Big Dipper set below the horizon. For this reason, the Big Dipper is called a circumpolar constellation.

It is important to note that your latitude will determine the constellations that you are able to see. In Saskatoon the latitude is roughly 52 degrees. This means that people in Saskatoon can see some circumpolar constellations and some seasonal constellations. If you were standing on the top of the North Pole, you would only see circumpolar constellations and the North Star would be directly above you. You would see all the constellations rotate around the North Star. In Saskatoon we see the North Star 52 degrees above our northern horizon. If you were standing on the equator, the North Star would be directly on your northern horizon and you would be able to see all the constellations in the northern hemisphere and the southern hemisphere. If



you are standing at the equator, all the constellations are seasonal. The following two charts show you the circumpolar constellations and seasonal constellations in the northern hemisphere. These charts are handy because they tell you which constellations you will be able to see year round and which ones you can only see during a particular season.

---

**Circumpolar Constellations  
(we can see these year round)**

Ursa Major (Big Dipper) Ursa Minor Draco Cepheus Cassiopeia Camelopardalis
---

---

**Seasonal Constellations (we can only see these during particular seasons)**

<u>Winter</u>	<u>Spring</u>	<u>Summer</u>	<u>Fall</u>
Auriga	Bootes	Aquila	Andromeda
Canis Major	Cancer	Capricornus	Aquarius
Canis Minor	Canes Venetici	Corona Australis	Aries
Fornax	Centaurus	Corona Borealis	Cetus
Gemini	Coma Berenices	Cygnus	Lacerta
Horologium	Corvus	Delphinus	Pegasus
Lepus	Crater	Equuleus	Perseus
Monoceros	Hydra	Hercules	Pisces
Orion	Leo	Libra	Sculptor
Puppis	Leo Minor	Lyra	Triangulum
Taurus	Lynx	Ophiuchus	
	Sextans	Scorpius	
	Virgo	Scutum	
		Serpens	
		Sagitta	
		Sagittarius	
		Telescopium	
		Vulpecula	

# Navigating Around the Sky

In astronomy there are some tips and tricks that are useful when trying to find certain constellations and celestial objects. This section will show you how to find some common constellations and will explain some tips and tricks that are useful when it comes to navigating around the night sky. We'll start by looking at the Big Dipper:

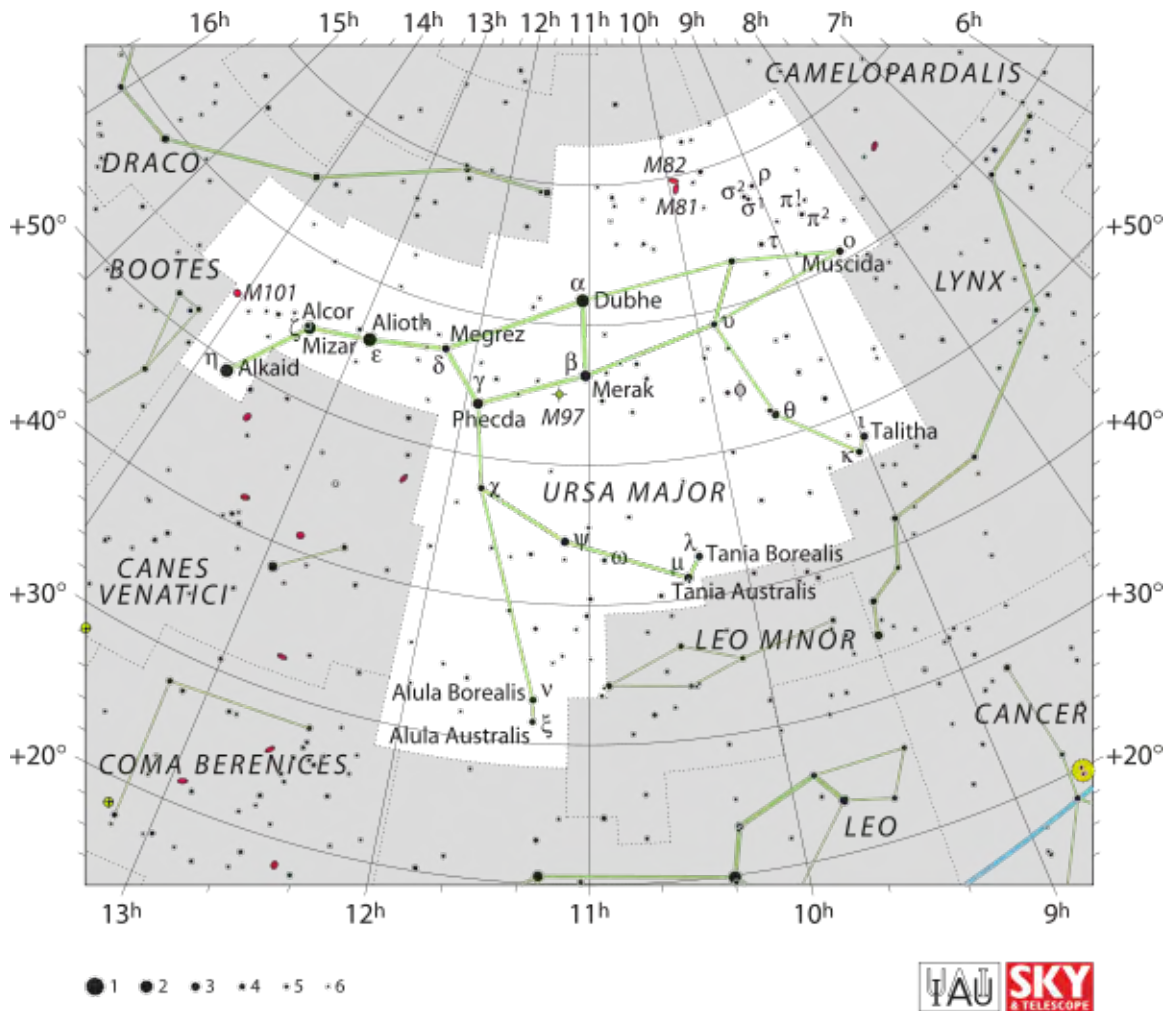

Wikipedia, IAU and Sky & Telescope magazine, Roger Sinnott & Rick Fienberg, 2011

### Finding the North Star Using the Big Dipper

The Big Dipper is very useful for navigation because this constellation can be used to locate the North Star, also known as Polaris. The North Star will stay in the same spot in the sky all year round so if you find the North Star, you will always know which way is north. The two stars that make up the outer edge of the Big Dipper, Merak and Dubhe, always point directly towards the North Star. Once you find the North Star, then you can easily find the Little Dipper, otherwise known as Ursa Minor, the smaller bear. The Little Dipper looks like a smaller mirror image of the Big Dipper.

*Finding Polaris (the North Star)  
using the Big Dipper, Wikipedia,  
NASA, 2009*

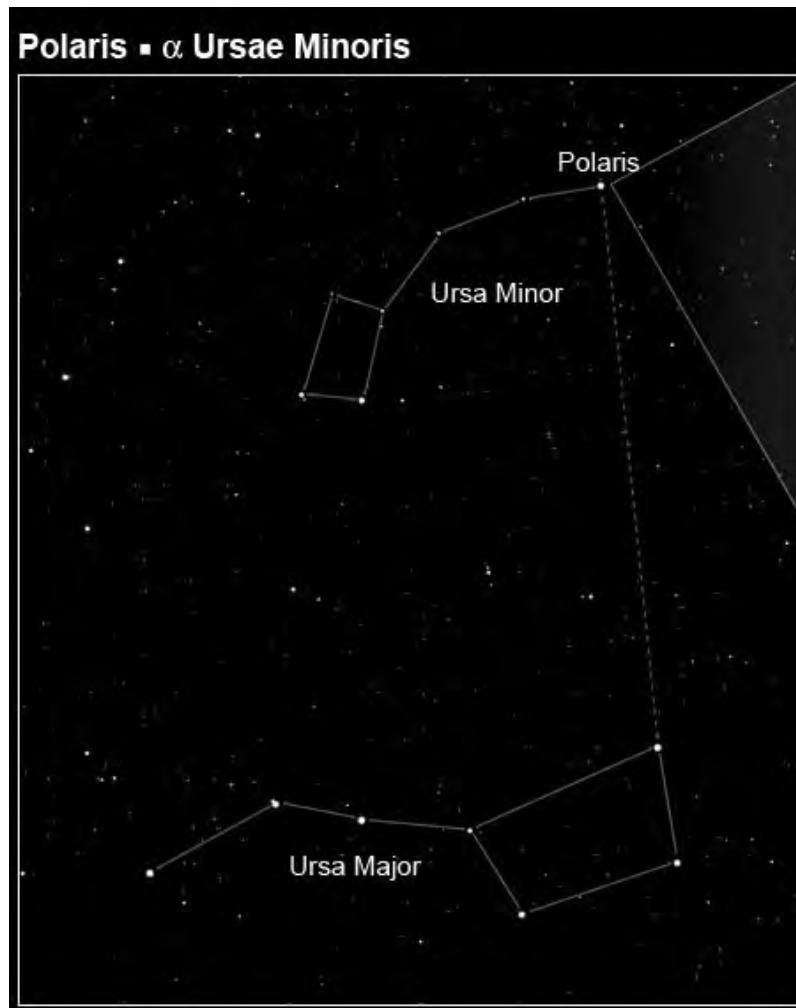

### Finding Arcturus and Spica using the Big Dipper

There are two interesting stars that you can easily find using the handle of the Big Dipper. These two stars are Arcturus and Spica. Arcturus is located in the constellation Bootes and is an orange giant star. Spica, although much dimmer than Arcturus, is the brightest star within the constellation Virgo. To find Arcturus, just remember the phrase “Arc to Arcturus, then spike to Spica.” The arc is referring to the handle of the Big Dipper. Once you find Arcturus by following the arc, then you just need to keep following that path to find Spica.

Arc to Arcturus,

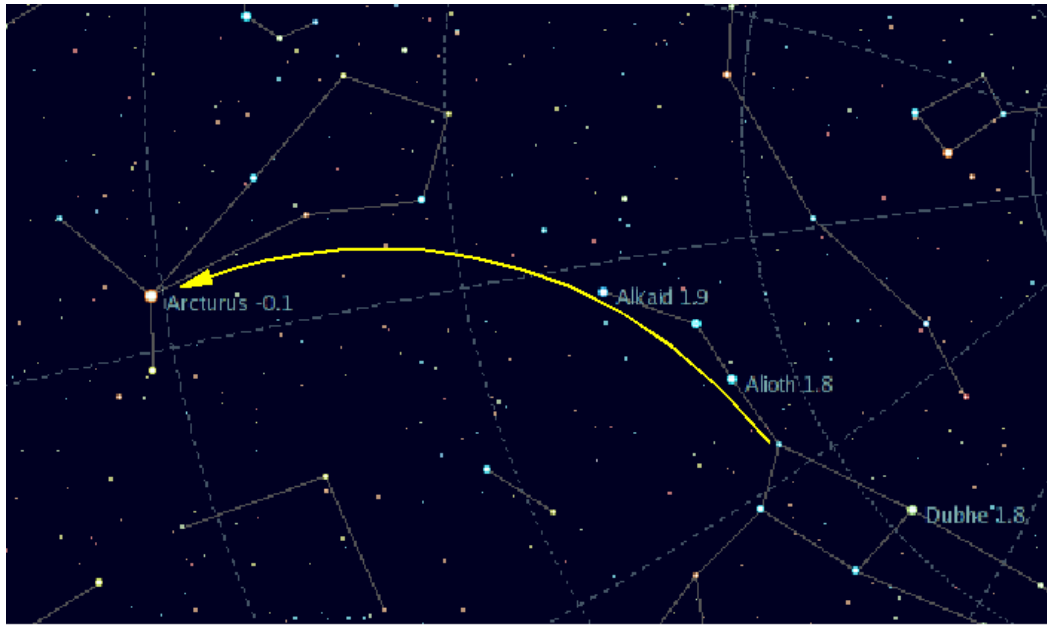

then spike to Spica.



## Using the Summer Triangle

The summer triangle is a pattern in the sky that can be seen during the summer months. The summer triangle is formed by connecting three bright stars: Deneb, Altair and Vega.

Each of the stars that make up the summer triangle is part of a different constellation. If you can find the summer triangle, then you can easily find the three constellations Cygnus (the Swan), Lyra (the Harp) and Aquila (the Eagle).

Deneb makes up the tail of Cygnus, the Swan and the body runs along a line towards Albireo which is the head of the swan. Vega is the third brightest star in the northern hemisphere and is located in Lyra, the Harp:

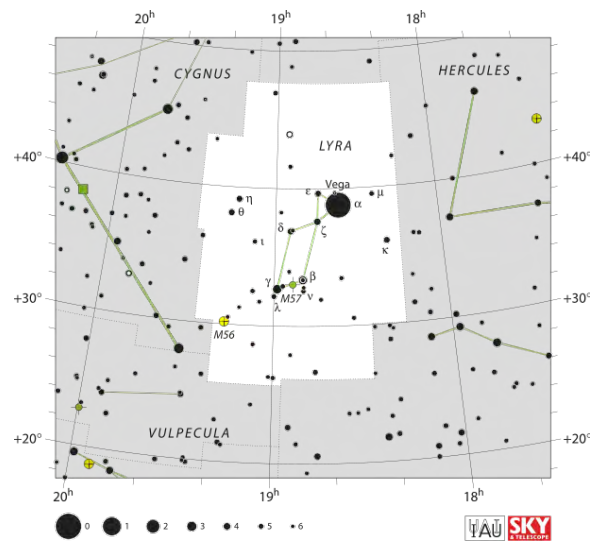
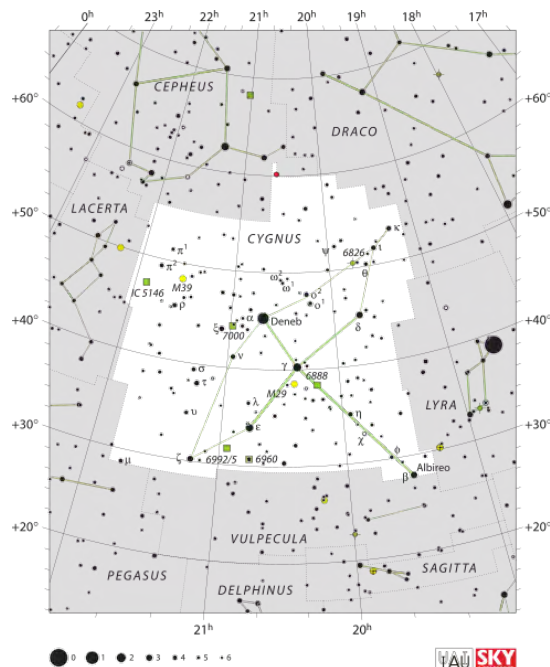
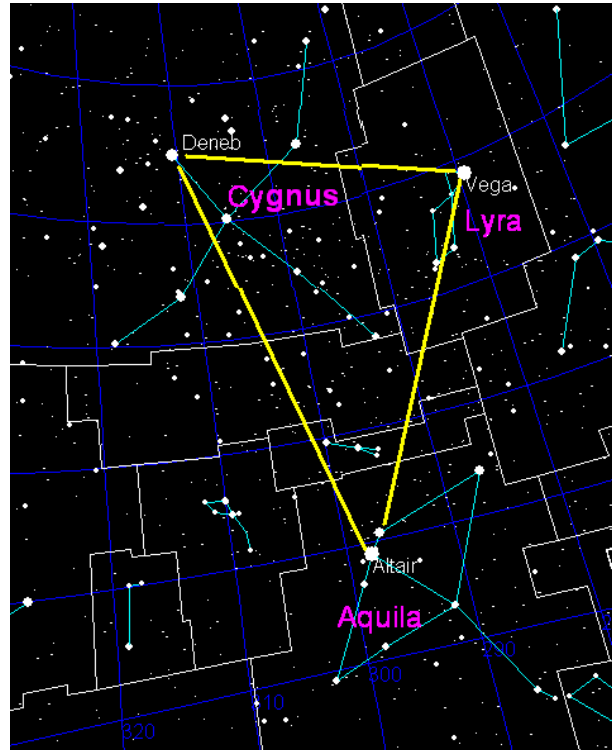

Wikipedia, IAU and Sky & Telescope magazine, Roger Sinnott & Rick Fienberg, 2011





# How to Find Some Common Constellations

## Cepheus and Cassiopeia

Cepheus and Cassiopeia are circumpolar constellations and they are fairly close to the North Star (Polaris). If you can find the North Star then look for a pattern of stars that almost looks like a house (or an upside down house, depending on your orientation). If you find a pattern that looks like a house, that is Cepheus. Cassiopeia has the shape of a “w” and is right beside Cepheus. See the star chart at right.

*Wikipedia, IAU and Sky & Telescope magazine, Roger Sinnott & Rick Fienberg, 2011*

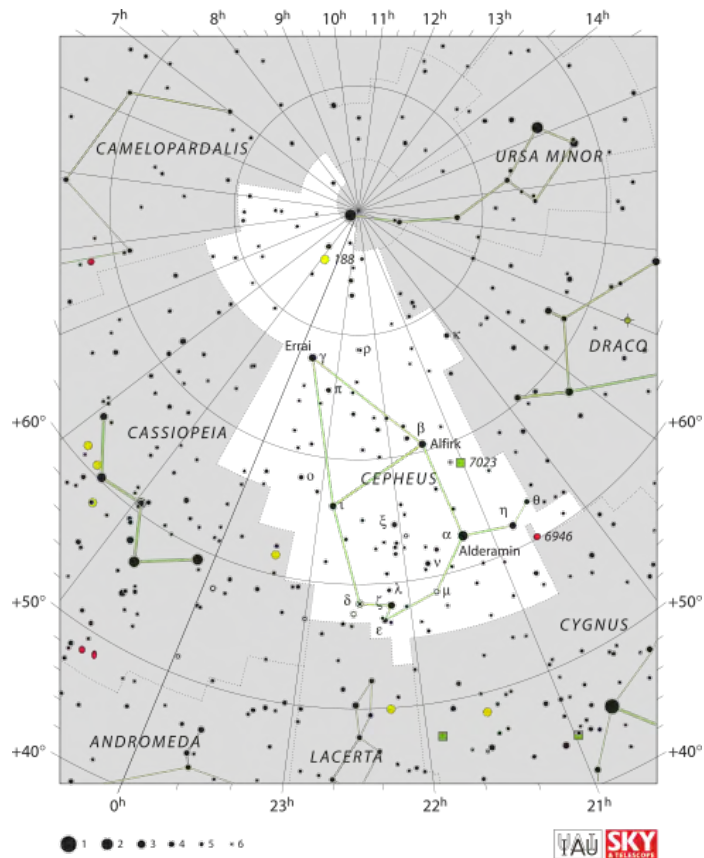

## Camelopardalis

Camelopardalis is a circumpolar constellation and is found in between Ursa Major and Cassiopeia. It is a fairly faint constellation but it takes up a large part of the sky:

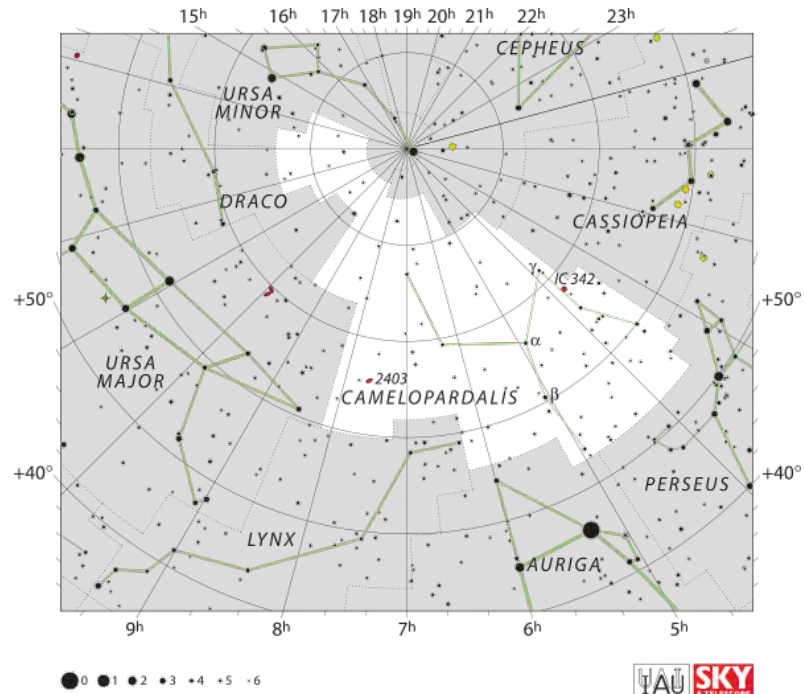

Wikipedia, IAU and Sky & Telescope magazine, Roger Sinnott & Rick Fienberg, 2011





## Perseus

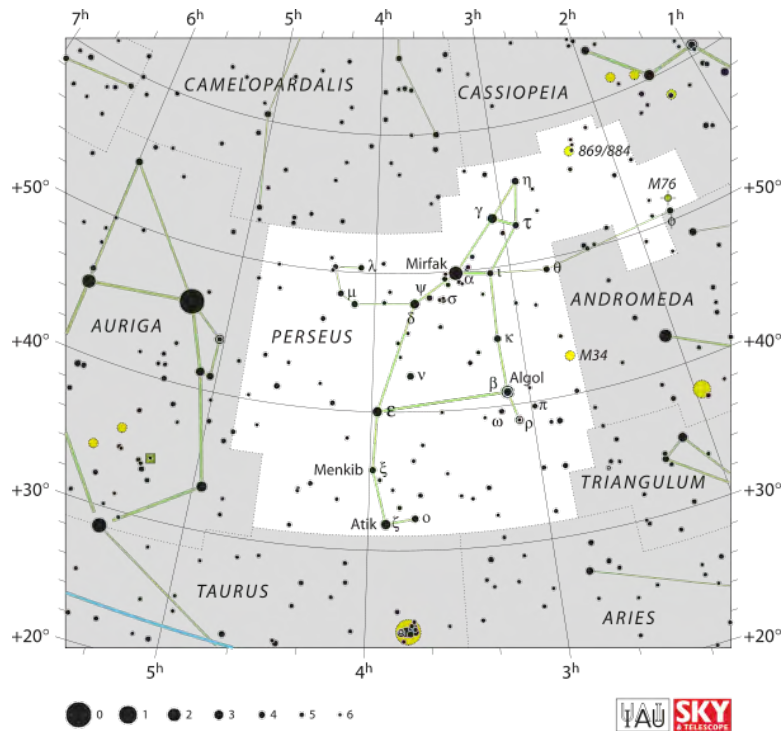

Perseus is a useful constellation to locate because within it is a famous double star cluster called NGC 869/844, a beautiful star cluster that is visible even with your naked eye or a pair of binoculars. The Perseus constellation is just below Camelopardalis and borders Andromeda and Auriga.

*Wikipedia, IAU and Sky & Telescope magazine, Roger Sinnott & Rick Fienberg, 2011*



## Hercules

Hercules contains one of the most well known globular clusters called M13 or the Great Cluster of Hercules. The torso of Hercules is made of four stars and the arms and legs extend out from each of these four stars. To find Hercules, start by finding the constellation Lyra - Vega is a bright star within Lyra that you can look for. Hercules is just to the east of Lyra. The other constellations that border Hercules are Bootes, Draco, Ophiuchus and Corona Borealis.

*Wikipedia, IAU and Sky & Telescope magazine, Roger Sinnott & Rick Fienberg, 2011*

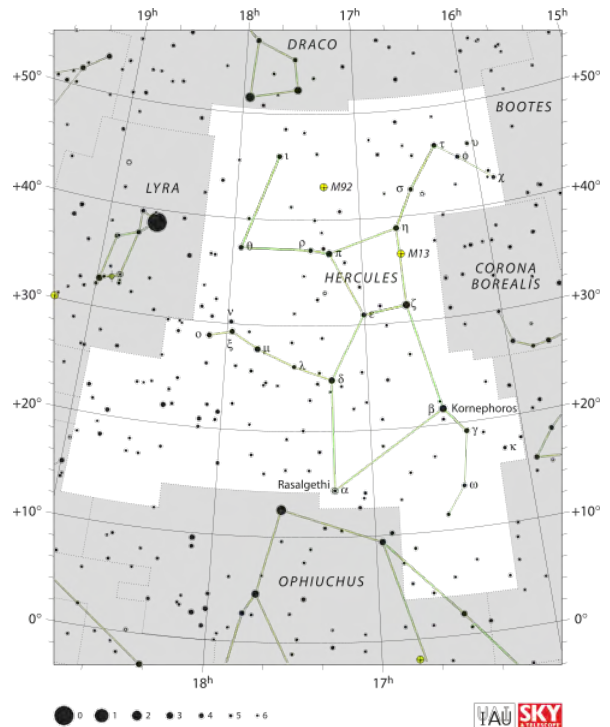



## Pegasus and Andromeda

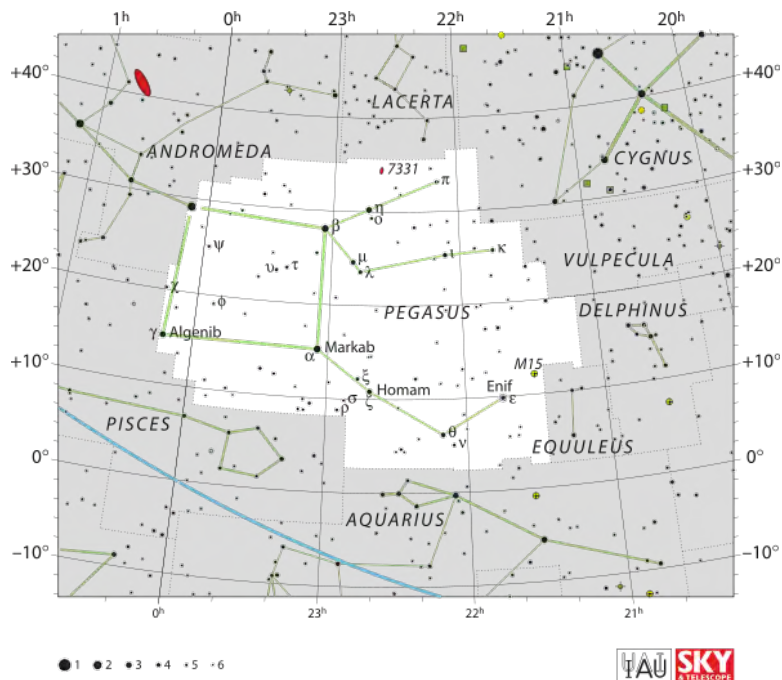

Pegasus and Andromeda are constellations that are side by side and appear as if they are connected together. Pegasus borders Cygnus, the Swan so find Cygnus first and then look to the east of Cygnus to find the square of Pegasus. Go to the top left hand star of the Great Square of Pegasus and follow a line of stars to the east, this will take you along the Andromeda constellation.

*Wikipedia, IAU and Sky & Telescope magazine, Roger Sinnott & Rick Fienberg, 2011*



Andromeda contains the closest Galaxy to us called M31 or the Andromeda Galaxy. M31 is visible with your naked eye, but it looks even better with a telescope.

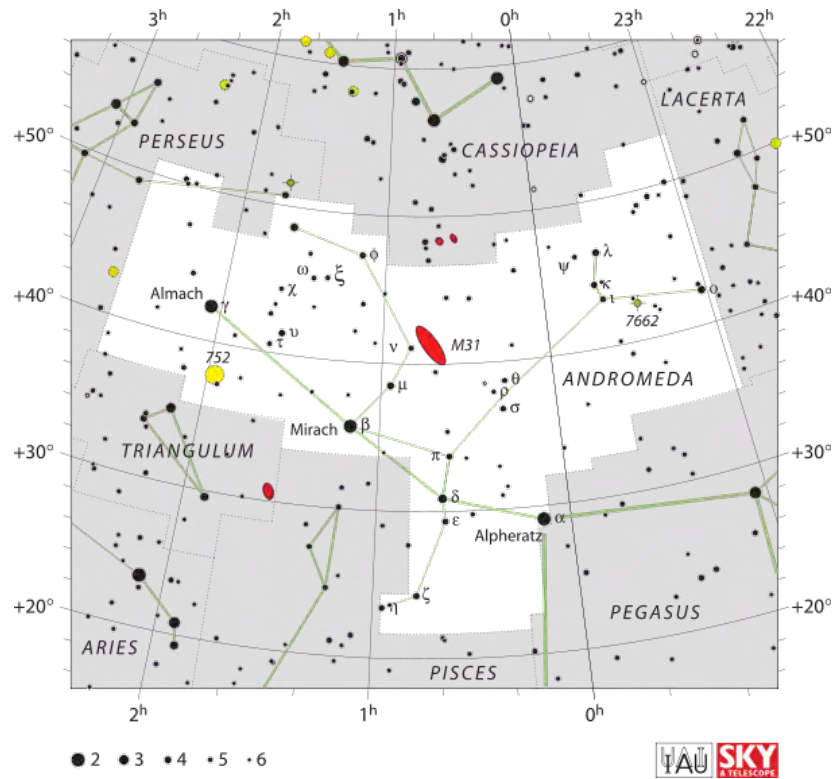

Wikipedia, IAU and Sky & Telescope magazine, Roger Sinnott & Rick Fienberg, 2011



## Orion

Orion is a winter constellation and is located in between Taurus, Auriga and Gemini. A characteristic feature of Orion is the belt that is made up of three bright stars. Below the belt is a vertical line of stars that make up the sword. Orion contains a beautiful emission nebula called M42 or the Orion Nebula which is visible with your naked eye. M42 is located within the sword of Orion.

*Wikipedia, IAU and Sky & Telescope magazine,  
Roger Sinnott & Rick Fienberg, 2011*

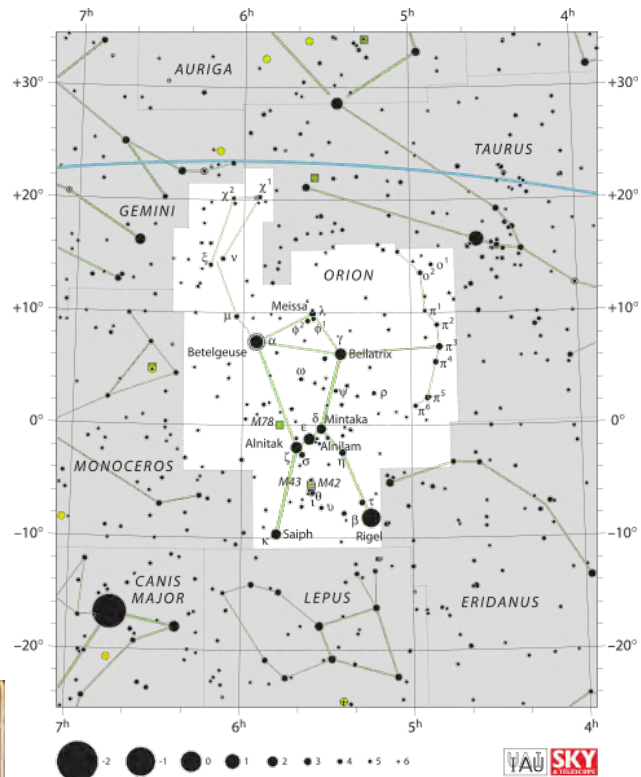



## Gemini

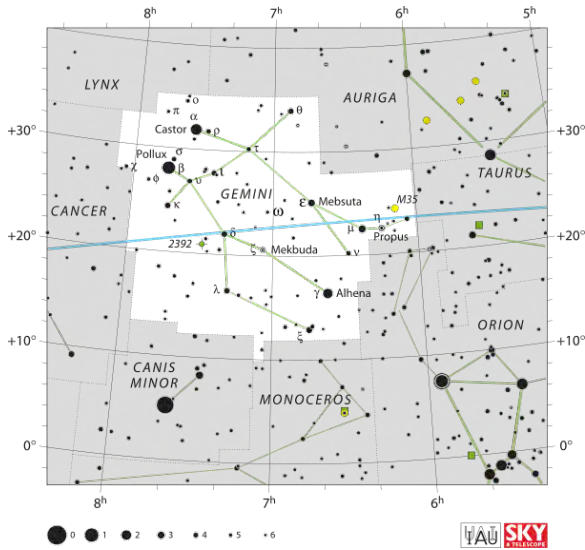

The two notable stars in Gemini are Castor and Pollux, which make up the heads of the twins. The bodies of the twins extend down from there, taking up a large area of the sky. Gemini lies in between Taurus and Cancer and is easily recognizable in the winter months by locating Castor and Pollux.

*Wikipedia, IAU and Sky & Telescope magazine, Roger Sinnott & Rick Fienberg, 2011*

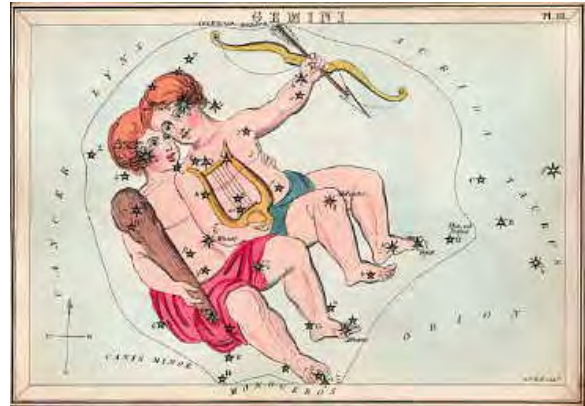

## Bootes

Bootes is a spring constellation that is home to one of the brightest stars in the sky, Arcturus. Bootes is surrounded by some prominent constellations such as Ursa Major, Virgo, Canes Venetici and Hercules.

In mythology, Bootes is the herdsman with his hunting dogs (represented by Canes Venetici). His oxen are attached to the rotation axis keeping the skies in perpetual rotation.

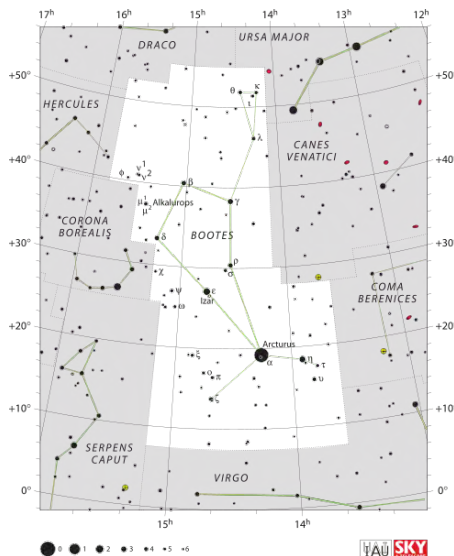

*Wikipedia, IAU and Sky & Telescope magazine, Roger Sinnott & Rick Fienberg, 2011*

# Chapter 5 The Moon

---

## What is the Moon?

A moon, also called a satellite, is a relatively small object that is orbiting around a planet. Earth's moon is the fifth biggest moon in the solar system. As we will see, several other planets in the solar system also have moons. On average, the distance between the Earth and the moon is 384,000 kilometres. To give you an idea of its size, the moon is about four times smaller than the width of the Earth. You could fit the moon inside the Earth about 50 times before filling it up. It is suspected that the moon formed about 4.5 billion years ago through a catastrophic collision with an asteroid and the proto-Earth. Then, over time, the Earth-Moon system was formed:



*Artists rendition of moon formation,  
Wikipedia, NASA, 2009*



*Earth-Moon system captured by Galileo spacecraft in 1992*



## Phases of the Moon

The gravity of the Earth pulls on the moon such that one face of the moon is always facing us, and we can never see the other side. Just like the Earth, half of the moon is always lit by sunlight and the other half is in shadow. As the moon orbits the Earth, we see a different phase of the moon. It takes about 27 days for the moon to orbit the Earth so we see the moon go through all eight phases within about a month.

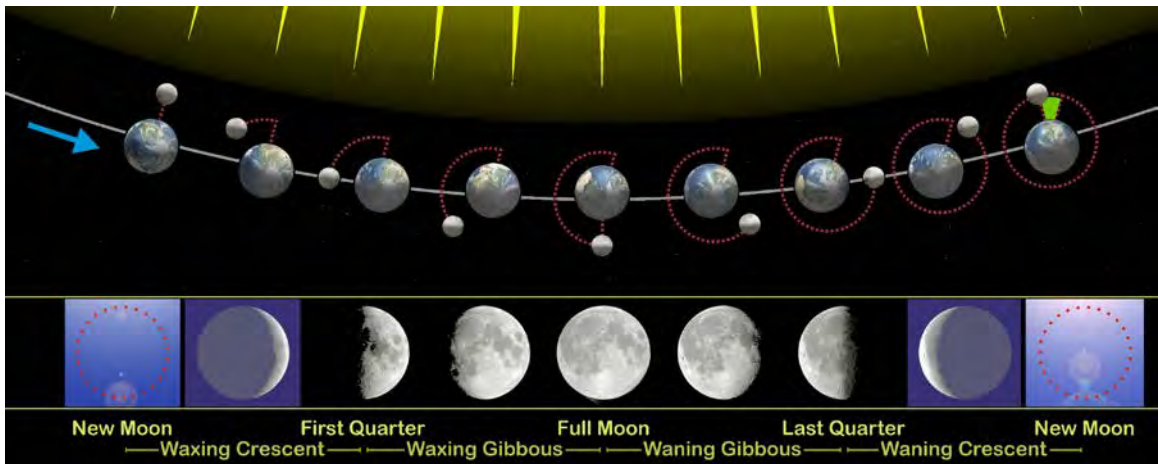

*Wikipedia, Orion 8, 2010*

When the Earth is in between the moon and the sun, the illuminated side is pointed toward us and so we see a full moon – the face of the moon is lit up.

*Full Moon, Wikipedia, Gregory H. Revera, 2010*



After a full moon, the surface will gradually creep into darkness, starting with a waxing gibbous phase.

*Waxing gibbous moon, Wikipedia, John Spade, 2011*



Next is first quarter.

*First Quarter moon, WikiCommons,  
NASA Goddard Space Flight Center, 2011*



Then we have a waxing crescent phase. This is the phase right before we see the surface of the moon covered in shadow.

*Waxing crescent moon, WikiCommons, Thomas Bresson, 2010*



When the moon is exactly in between the Earth and the sun, the illuminated side is pointed away from us so the face of the moon is dark and we are unable to see it during this phase. As the moon continues to orbit the Earth, sunlight will gradually creep across the surface. First we will see waning crescent.

*Waning Crescent, WikiCommons, ESO, 1999*



Next we will see third (last) quarter:

*Third quarter moon, Wikipedia, Orion 8, 2010*



And lastly we will see a waning gibbous phase. This is just before the cycle starts over with a full moon:

*Waning gibbous moon, WikiCommons, Thomas Bresson, 2013*



## Harvest Moon

Have you ever heard someone refer to the moon as a harvest moon? A harvest moon is a full moon that happens in the fall. A full moon can be bright enough that farmers can keep harvesting late into the night. You may have noticed that during a full moon, the moon appears much bigger and orange or red in colour when it is located just above the horizon. When the moon looks like this it is commonly misinterpreted as a harvest moon. In fact, the appearance of the moon as big and orange has nothing to do with a harvest moon – a harvest moon only has to do with the full moon that coincides with the harvesting of crops.



*Harvest Moon, WikiCommons, RoadCrusher, 2007*

The reason that a moon appears larger and red or orange along the horizon has to do with the scattering of light in the Earth's atmosphere. There is more atmosphere that the moon light has to travel through along the horizon so there is more scattering of light compared to when it is high in the sky. This is the same reason why sunrises and sunsets can have such spectacular colours but when the Sun is high in the sky during the day there is no longer as much colour.

## Tips for Observing the Moon

You can easily observe the moon with your naked eye, a pair of binoculars or a telescope. If you plan to observe the full moon with a telescope or binoculars, be advised that it can be very bright. If you plan to view the full moon with a telescope, you may choose to purchase a moon filter, which can reduce the amount of light that enters your eye.

When the moon is full it is very difficult to see any details because there are very few shadows on the surface. When the moon is new it is impossible to see it because there is no light being cast on the surface. The best times to observe the moon are first and third quarter. During these phases you can see a lot more detail on the surface of the moon. The reason that first and third quarter are the best phases for viewing is because sunlight is hitting the moon from the side, causing shadows to be cast by the mountains and craters. Refer to the images of first and third quarter near the beginning of this section to see the shadows on the surface of the moon compared to when the moon is full.

# Eclipses

There are two types of eclipses, solar eclipses and lunar eclipses. During a new moon, if the sun, the moon and the Earth line up just right, a solar eclipse will occur. During a total solar eclipse the outermost layer of the sun, the corona, is visible:



*Total solar eclipse, Wikipedia,  
Luc Viatour, 1999*

A solar eclipse happens when the moon passes in front of the sun causing the sunlight to be partially or fully blocked out. A solar eclipse can be full, partial or annular depending on the position of the moon in space and depending on your location on Earth.

Referring to the diagram below, you will witness a total solar eclipse if the moon is positioned in space such that your position on Earth falls within the umbra, the area of full shadow (A). You will witness an annular eclipse if the moon is a bit too far away for the umbra to reach the Earth causing the outer edge of the sun to be visible around the moon (B); this area is called the antumbra. You will witness a partial solar eclipse when your position on Earth falls within the penumbra, the area of partial shadow (C).

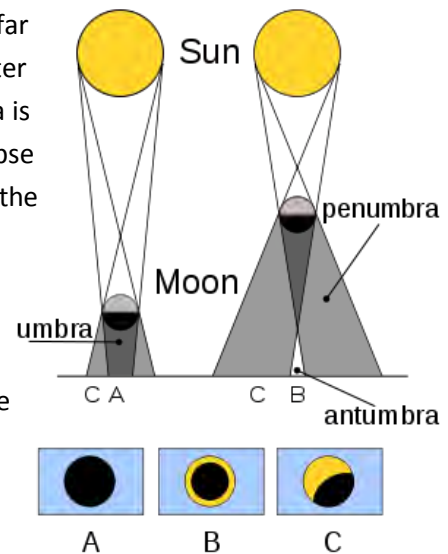

*Wikipedia, Setreset, 2010*



*Solar eclipse glasses, Wikipedia, Bree, 2006*

During a full moon, if the sun, the moon and the Earth are lined up just right, then a lunar eclipse will occur. A lunar eclipse occurs when the Earth passes in between the moon and the sun, causing a shadow to be cast onto the moon. The moon will be partially or fully blocked out during a lunar eclipse.



*Lunar eclipse, Wikipedia, Jiyang Chen, 2010*

Note that it is safe to view the moon at any time without protective eyewear. The moon is not bright enough to damage your eye.

Referring to the diagram below, a total lunar eclipse will occur if the moon passes through the umbra (the darkest shadow being cast by the Earth). A partial lunar eclipse will occur if only a portion of the moon passes within the umbra. If the moon passes through the penumbra (partial shadow), then only a slight darkening on the surface of the moon will be visible.

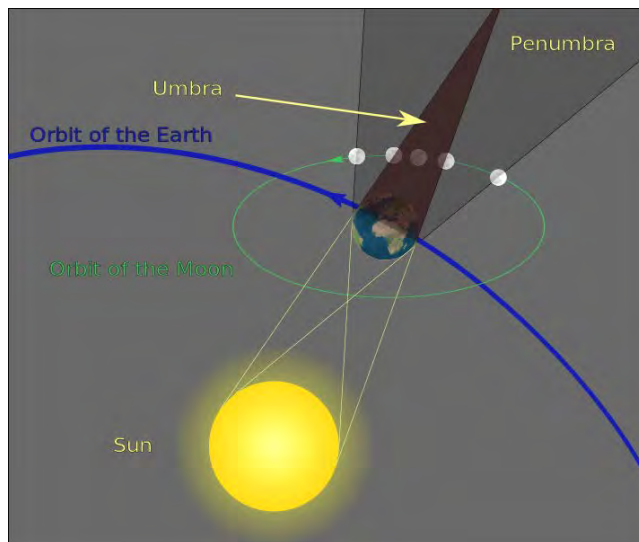

*Wikipedia, Sagredo, 2008*



# Chapter 6 The Solar System

---

## Getting to Know the Sun and the Planets

All eight planets orbit around the sun along the same plane of orbit. The four inner planets are considered “rocky planets” because they contain relatively dense, rocky material with relatively little atmosphere. The four outer planets are considered “gas giants” because they are primarily made of gases like hydrogen and helium and they are much larger than the inner four planets. Let us take a look at the eight planets in some more detail.

### The Sun

The Sun is the closest star to us – about eight light minutes away. Even though the sun is a mid-sized star, it is unimaginably huge. You could fit about 109 Earths side by side within the sun. The sun is responsible for providing light in the solar system. If it was not for the sun, there would be no plant-life as we know it on Earth. Plants are the basic food provider for most of the life on Earth. So we owe a lot to the sun for keeping the Earth bathed in sunlight.

The surface of the sun contains sunspots which are darker areas on the surface. These sunspots are cooler areas on the surface. On average the surface temperature is 5,400 degrees Celsius, a sunspot might be a thousand degrees cooler.

*Sun with Sunspots, WikiCommons, NASA, 2011*

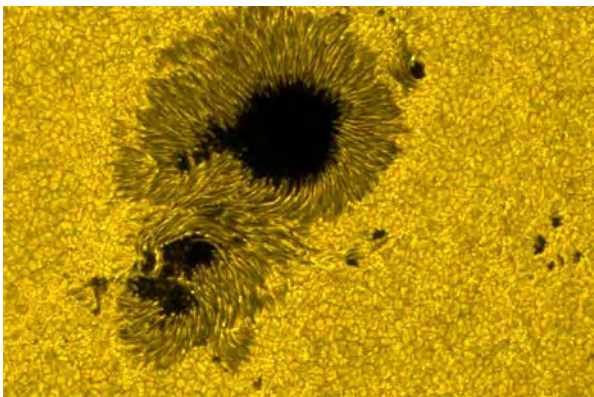
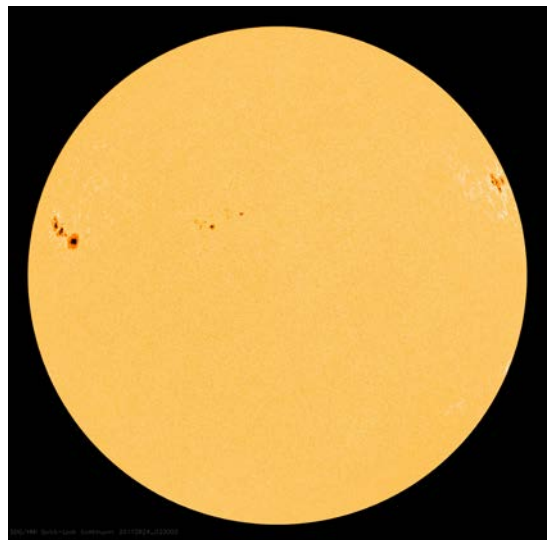

*Close-up of sunspots, Wikipedia, NASA, 2006*

Be careful! Never look at the sun directly with your naked eye and **do not** point your telescope or binoculars towards the sun as this can cause severe damage to your eye. If you plan to do solar observing with your telescope ensure that you do plenty of research and purchase a quality solar filter that allows safe viewing through your telescope.

### Mercury

Mercury is the first planet out from the sun. Mercury has virtually no atmosphere because it is close enough to the sun that the atmosphere has evaporated. The surface temperature of Mercury ranges from -173 degrees Celsius on the dark side of the planet to 426 degrees Celsius on the side facing the sun. When you look at a photo of Mercury it almost appears like Earth's moon because it is covered with craters. One of the reasons why the moon and Mercury look so similar is because they are both lacking an atmosphere. Over millions of years the moon and Mercury have been bombarded with space rocks, and since they do not have an atmosphere in which these rocks can burn up, they will fall right to the surface and make a crater.

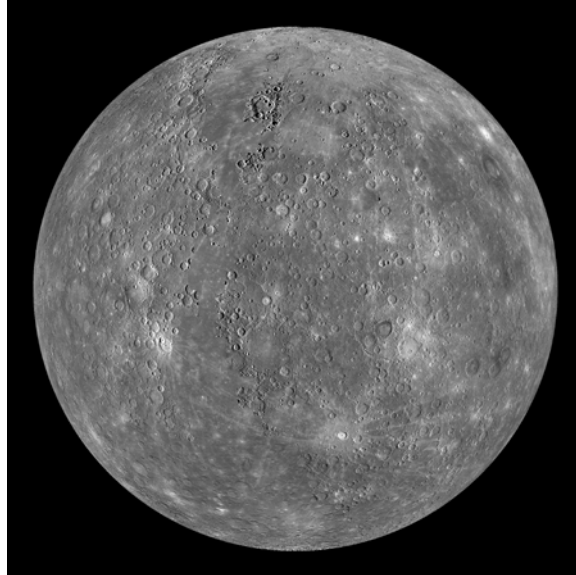

*Mercury, image taken by MESSENGER, Wikipedia, NASA, 2013*

Although Mercury can appear quite bright from the Earth, it is rather difficult to observe since it is so close to the Sun. The only times that it can be visible are at sunrise, sunset or during a solar eclipse. Mercury, being on the inside of Earth's orbit, goes through a series of phases very similar to the moon.

### Venus

You may be surprised to know that despite Venus being the second out from the sun, it is the hottest and brightest of all the planets. The reason for this is because of its thick, dense atmosphere. The atmosphere of Venus is made primarily of carbon dioxide, water vapour and sulphuric acid droplets – it's not a very pleasant place. Because of its dense atmosphere it will let in ultraviolet wavelengths of light and trap them there. The UV light will bounce off the surface of the planet and rebound off the atmosphere back to the surface of the planet, causing the planet to heat up. Almost like a kitchen oven, Venus stays very hot because it can't let the heat escape. Meanwhile, the visible wavelengths of light cannot penetrate the atmosphere of Venus and it just gets reflected back. This is why it appears so bright when we look at it:



*Mercury, Wikipedia, NASA, 1979*

Venus is inside the orbit of the Earth making it visible only when the sun is up, in the early morning or evening. For this reason Venus is also known as the morning star or evening star.



*Venus at Dusk, Wikipedia, Brocken Inaglory, 2008*

Like Mercury, Venus goes through a complete set of phases since it is on an inside orbit from Earth, as seen below:

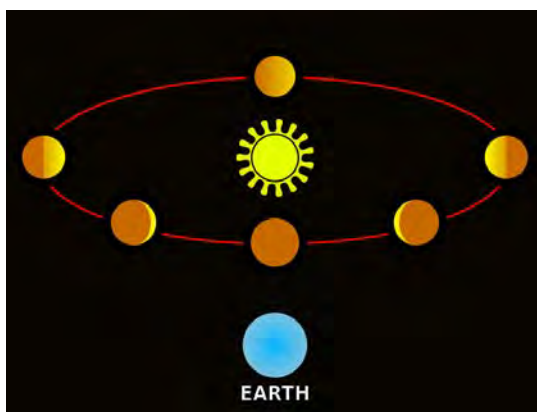

*Phases of Venus, Wikipedia, Nichalp, 2006*

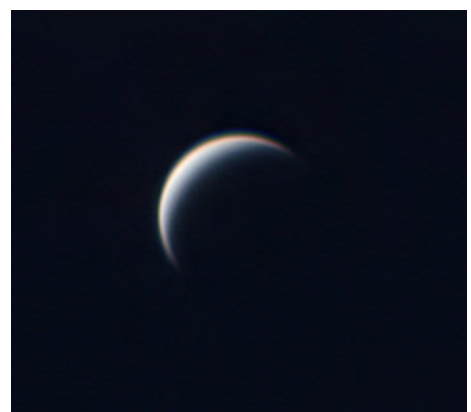

*Crescent phase of Venus, Wikipedia, Marc Leclaire, 2010*

## Earth

The Earth is the only planet that we know of that can sustain life. It is also the only planet we know of that has such an abundance of liquid water, an element that is required for life to thrive. The Earth is situated in what some people call the “Goldilocks Zone”. If the Earth was any closer to the Sun it would get too hot and the oceans could evaporate, any farther away and the Earth would quickly freeze. The Earth is found within a perfect location along its orbit that is not too hot and not too cold, making it a very habitable place for life forms. That being said, we know that there are some very extreme environments where we know life can thrive, like in the deep sea where no sunlight can reach. In some parts of the deep sea there are hydrothermal vents where scalding hot poisonous gases seep through the Earth’s crust into the oceans. Surprisingly, this environment is a place where life can thrive:

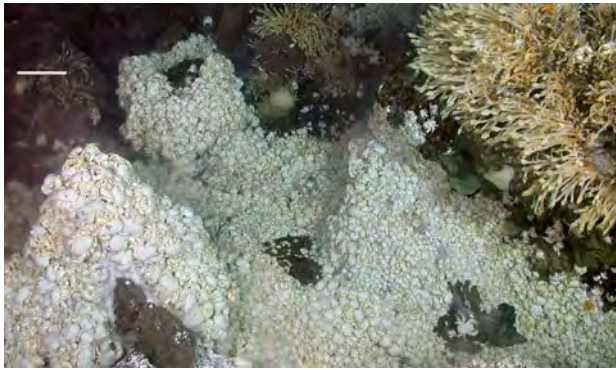

*Dense population of crabs and barnacles around hydrothermal vent, Wikipedia, A.D. Rogers, 2001*

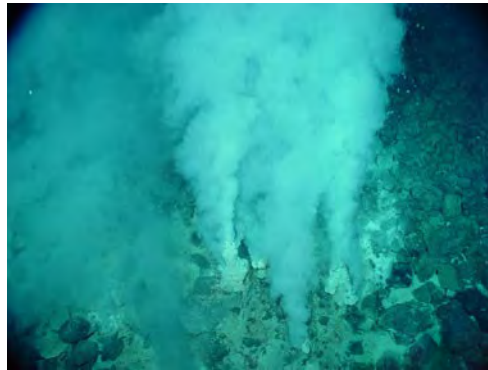

*Bacterial colonies around white smokers (>100°C), Wikipedia, NOAA, 2004*

If life can thrive in what we would consider to be the worst of conditions, perhaps there are places on other planets in our solar system or beyond where life is thriving, life that we have never encountered before. Scientists are currently on the search for other planets out there in our universe and some are quite possibly similar to Earth. What a wonderful and awe-inspiring notion to think that we may one day stumble upon an entirely new species or even a civilization on a planet far away from our own.



*Earth as seen from Apollo 17, Wikipedia, NASA, 2012*



Some astronomers believe that life beyond the Earth may even be found within our solar system. For example, Jupiter's moon Europa is considered a potential candidate for harbouring life. Europa is known to have a high abundance of water over its surface but it is frozen solid. It is thought that the underneath the ice is liquid water, a potential place where small microbes and creatures may exist.

*Europa seen from Galileo Spacecraft, Wikipedia, NASA, 2006*

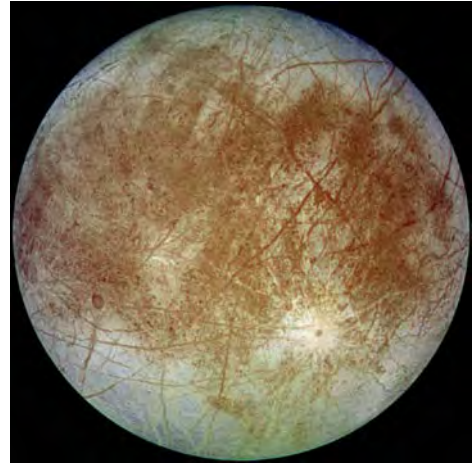

Missions by space organizations are currently being planned to study, understand and even explore Europa on a deeper level.

### **Mars**

Mars is known as the "Red Planet" obviously because it appears red when you look at it. The reason that it is red is due to a high abundance of iron in its soil. This iron rich material oxidized which means it has rusted, giving the planet a red colouration.

Mars is a great planet for viewing since its red colouration makes it fairly easy to locate in the sky.

*Mars as seen from Surveyor, NASA, Wikipedia, 2012*

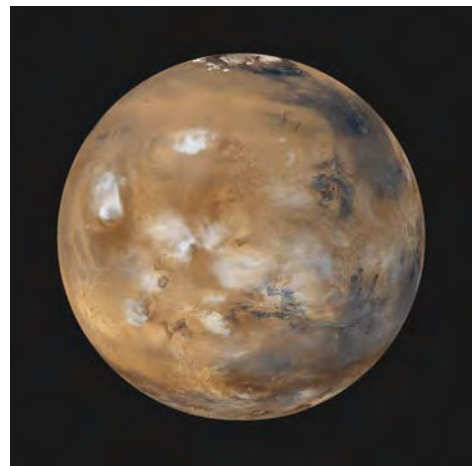

### **Jupiter**

Jupiter is known as the Lord of the Planets because of its size. Jupiter is so big that when it was conceived in the early solar system, it was almost big enough to start burning like a star. Instead, it maintained a smaller size and is considered the largest body in the solar system other than the sun. Like all the gas giants, it is mostly made up of hydrogen and helium.

*Jupiter as seen from Cassini Spacecraft, Wikipedia, NASA, 2000*



Jupiter is known for four of its moons: Io, Europa, Callisto and Ganymede. These four moons are easily visible when you look at Jupiter, with even a lower powered telescope. In some cases you may be able to make out the moons with a pair of binoculars.

Sometimes you can't see all of the moons because as the moons follow their orbit around Jupiter, one or more moons may be hidden on the far side of the planet. Another visible feature of Jupiter is its atmosphere. When you look at it you will likely be able to see darker and lighter bands running across the surface. These bands are convective wind currents within the atmosphere of Jupiter.



*Great Red Spot on Jupiter taken by Voyager 1, Wikipedia, NASA, 1979*



*Jupiter with Galilean Moons, Wikipedia, stewartde, 2008*

Jupiter is also known for the Great Red Spot, which is a torrential windstorm in Jupiter's atmosphere that has been going on for at least several hundred years. The Great Red Spot tends to fluctuate in size and at its largest you could fit three Earths side by side within the storm.

## Saturn

Because of its rings, Saturn is probably the most favoured planet of all by stargazers. Like all the outer gas giants, Saturn is primarily made up of hydrogen and helium. Saturn's rings are readily visible with a reasonably powered telescope. The rings are made up of a disk of rocky and icy material. Saturn is the second largest planet in the solar system after Jupiter. One of Saturn's moons, Titan, is quite large and can usually be seen along with Saturn when you look at the planet:

*Saturn with moons as seen from Voyager 2, Wikipedia, NASA, 1981*





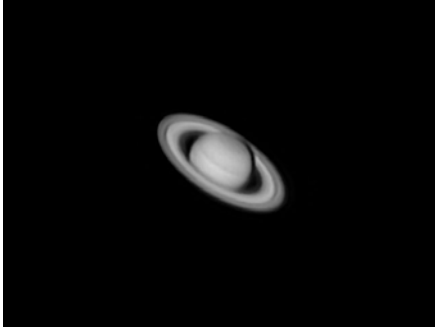

To the left is an image of Saturn that is representative of what it would look like through a modestly powered telescope.

*Wikipedia, Rochus Hess, 2004*

## Uranus

Uranus is the coldest planet in the solar system and can drop to a temperature of -224 degrees Celsius. Uranus is similar in composition to Jupiter in that it is primarily hydrogen and helium. The difference is that Uranus has a greater abundance of water, methane and ammonia making it have a bluish colour. Uranus has an interesting tilt in that its rotation axis is perpendicular to the plane of its orbit. To put it simply, Uranus rolls along its orbit much like a car tire rotates on a road. Uranus can be very difficult to locate and observe unless it's done with a fairly high-powered and well calibrated telescope.

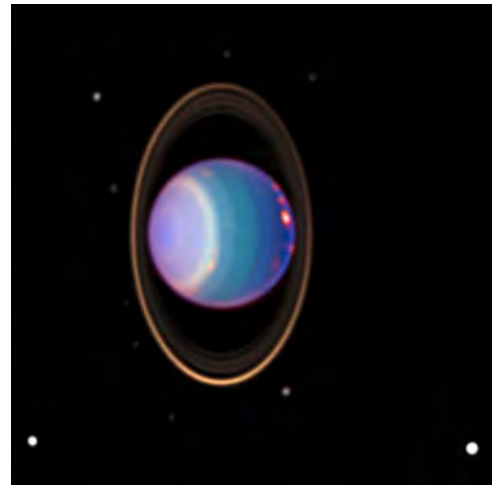

*Uranus with rings and moons, Wikipedia, NASA, 2005*

## Neptune



Neptune, named after the Roman God of the sea, is very similar in composition to Uranus, in that it is primarily hydrogen and helium, but there is also an abundance of methane, ammonia and water. Neptune is the farthest planet from the Sun within the solar system. It is about 30 times the distance between the Earth and the Sun (roughly 4.5 billion kilometres). Like Uranus, Neptune can be quite difficult to locate and observe unless it is done with a fairly high-powered and well-calibrated telescope.

*Neptune as seen from Voyager 2, Wikipedia, NASA, 1989*

## What about Pluto?

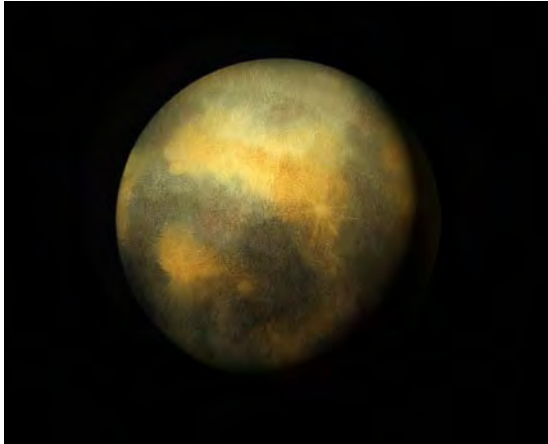

*Artists interpretation of Pluto,  
Wikipedia, C M handler, 2010*

If you are wondering why Pluto was not included in this list, it's because Pluto is no longer considered a planet. The reason that astronomers decided to demote Pluto is because there have been discoveries of objects beyond the orbit of Pluto that are actually larger – Pluto is fairly small, only about one sixth the size of Earth's Moon. So rather than

adding more planets to the solar system that are beyond the orbit of Pluto, astronomers decided to make a strict definition about what is considered to be a planet. In order to classify as a planet in our solar system, an object:

1. Must be orbiting the Sun.
2. Must be massive enough to be rounded by its own gravity (must be spherical like a ball).
3. Cannot be massive enough to burn like a star.
4. Must have cleared its orbit – so there can't be any large objects along its orbit.

Pluto has not cleared the neighbourhood of its orbit and is thought to be relatively close to the Kuiper Belt, a collection of about 70,000 rocky objects circling around the outer solar system. Pluto along with many other objects that are neither planets nor asteroids are now called Dwarf Planets:



*Largest objects  
known beyond  
the orbit of  
Neptune,  
Wikipedia,  
Lexicon, 2013*

## Finding Planets with your Telescope

Planets will be visible at different times depending on the year so the best idea is to keep track of when the planets will be up by checking websites, make use of iPhone or Android apps and contact a local astronomy club or observatory if there is one within your community. The easiest planets to locate with a telescope are Jupiter, Saturn, Mars and Venus because they are the brightest. When these planets are up in the sky they are usually quite easy to find with your naked eye, because of their brightness. One thing to keep in mind when locating a planet is that planets reflect light and do not generate their own light. With your naked eye you will notice that planets will twinkle less than stars do.

## Asteroids, Comets, Meteors and Meteorites

### Asteroids

Asteroids are small solar system objects that are irregular in shape. They are mostly made of rock and ice. Asteroids orbit the sun and are thought to be leftover pieces of the early solar system that never grew large enough to become planets. Many of the asteroids in the solar system are found within the asteroid belt between the orbits of Mars and Jupiter:

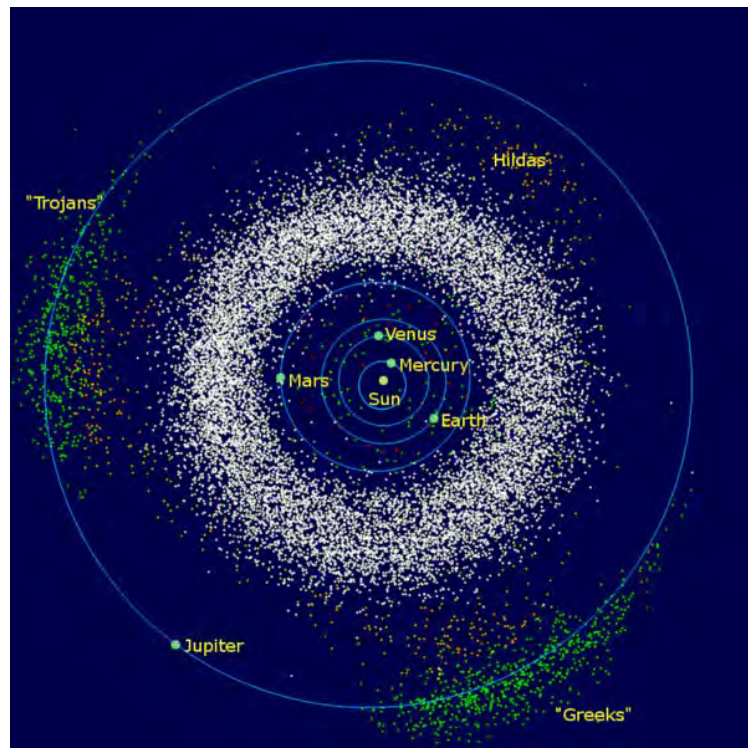

*Asteroid belt is shown in white, Wikipedia, Mdf, 2006*

## Comets

Comets are small solar system objects that are made up of rock and ice. They have three main parts: a nucleus (the rocky, icy centre), the coma (a cloud of gas and dust surrounding the nucleus) and a long tail. The comets that we know about have a size of up to 30 kilometres in diameter. Comets can come from virtually anywhere but there are some comets that are locked in orbit around the sun. When a comet comes close enough to the sun it will start to warm up and the ice will start to melt on its surface, creating a tail. An interesting thing about comets is that the tail will always point away from the Sun, as shown in this image.

*Comet parts, Wikipedia, NASA, 2006*

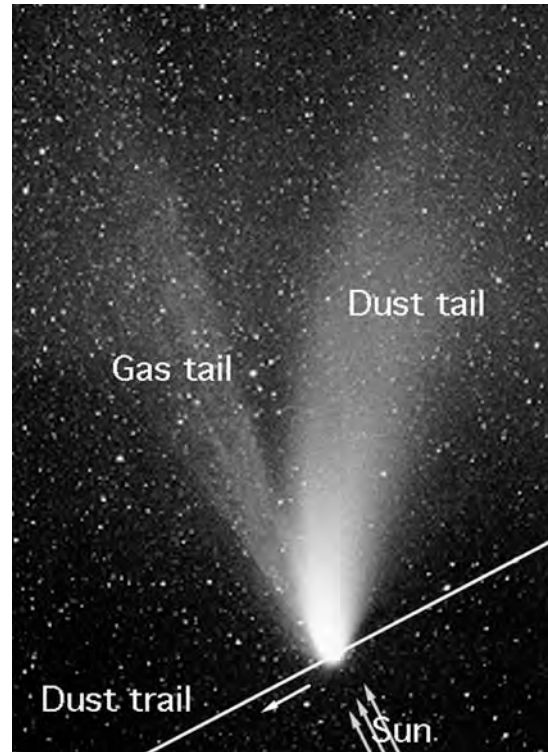

One of the most famous comets is Halley's Comet. This comet can be seen every 75 years and in the past it has been bright enough to see in broad daylight. Halley's comet last made an appearance in 1986 and will be seen again in 2061.

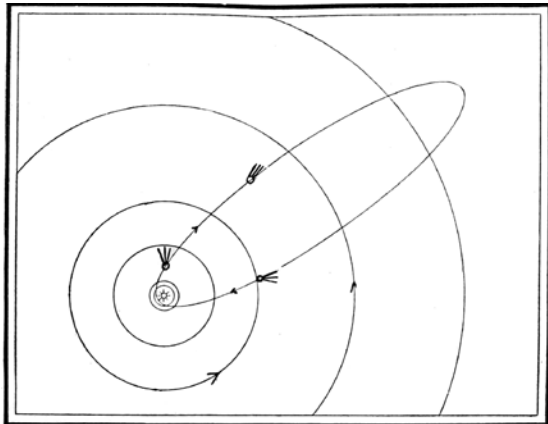

*Path of Halley's Comet orbit around the Sun, Wikipedia, Popular Science Monthly, 1910*



*Comet Halley seen in 1986, Wikipedia, NASA, 1986*

## Meteors and Meteorites

A common question is, "what is the difference between a meteor and a meteorite?" In fact they are almost the same thing. There is a lot of dust and debris flying around in the space just above

the Earth's atmosphere. Small particles, usually no bigger than a grain of sand, will get caught in the Earth's atmosphere, which is seen as a streak of light going across the sky. When you see a streak of light go across the sky it is called a meteor, otherwise known as a shooting star or a falling star. A meteor will burn up completely in Earth's atmosphere. A meteorite on the other hand does not completely burn up and will reach the surface of the Earth. If you are lucky enough to see a meteorite you will see it as a streak going all the way to the ground and it will appear as if a star had just fallen from the sky.

### Meteor Showers

During a meteor shower you may see dozens or hundreds of meteors within a single night.

Meteor showers can occur at any time throughout the year but there are some meteor showers that happen at roughly the same time every year. For example, the Orion meteor shower happens annually near the end of October. Meteor showers occur because as the Earth orbits the Sun, it will pass through areas of dust and ice left behind by comet tails. During this time there will be a spike in the number of meteors that are visible. After a few days, the Earth will pass through the debris and the number of meteors that you see will decrease.



*Long exposure image of Leonid meteor shower, Wikipedia, Juraj Tóth, 1998*

Meteor showers are named based on the constellation in which you will be able to see the most meteors. Here is a list of prominent annual meteor showers with the time of year in which they occur:

Name of Meteor Shower	Constellation	Time of Year	Typical Peak Meteor Frequency
Lyrids	Lyra	Mid-April	5-20 meteors per hour
Perseids	Perseus	Mid July - late August	60+ meteors per hour
Orionids	Orion	Late October	50-70 meteors per hour
Geminids	Gemini	Mid-December	120-160 meters per hour



## Aurora Borealis



*Northern lights courtesy of Tenho Tuomi, 2006*

If you live on an acreage or farm away from the city, and especially if you live in a more northern community you have likely seen the Northern Lights. The Northern Lights (also known as Aurora borealis in the northern hemisphere or Aurora australis in the southern hemisphere) look like a bright haze of glittering light along the horizon. You will see a stream of green, red, blue and/or purple light dancing along sky. The Northern Lights occur near the North or South poles because this is where the Earth's magnetic field originates. Northern lights are caused by charged particles that come all the way from the Sun. These particles will follow the magnetic field lines of the Earth and are directed into the Earth's atmosphere. The solar particles will collide with Earth's atmosphere and produce light that we can see.

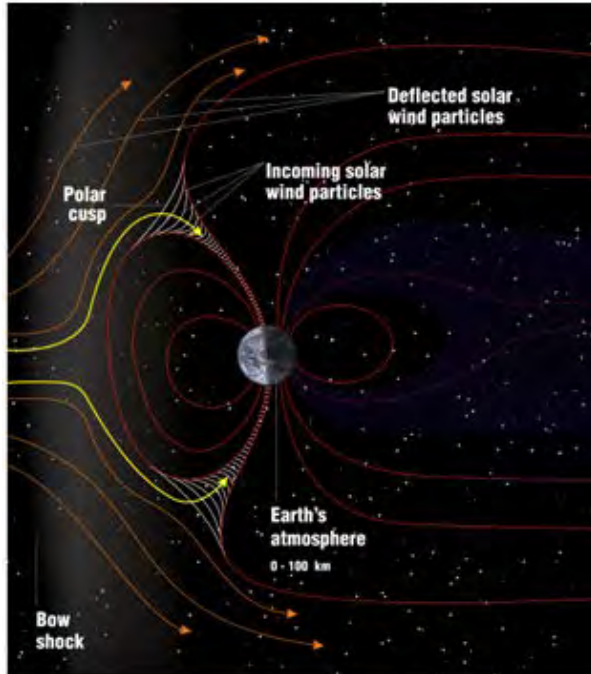

*Charged particles from the sun directed into the Earth's atmosphere, Wikipedia, NASA 2007*

Whether you northern lights that are green, yellow, red or purple depends on if the solar particles collide with oxygen or nitrogen in the Earth's atmosphere. Red and yellow light is emitted by oxygen while blue and purple light is emitted by nitrogen:

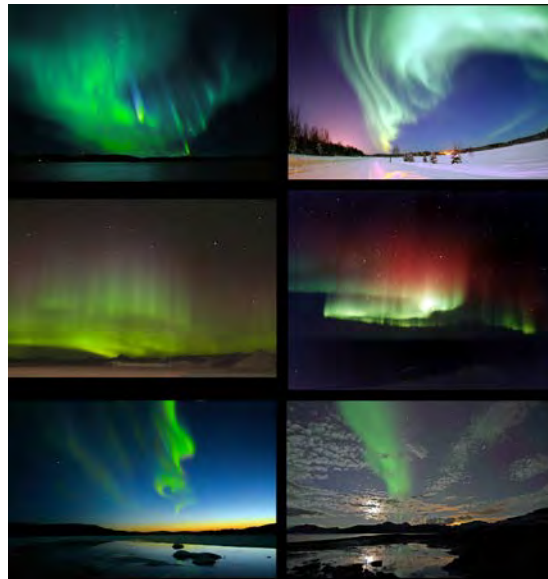

*Various aurora patterns seen from around the world, Wikipedia, 14jbella*

# Chapter 7 What are Stars?

## How Stars are Born, Live and Die

There are billions of galaxies in the universe and each galaxy contains billions of stars. Stars come in all different sizes, shapes and colours, but there are two things in common: they all give off light and they are all extremely hot. When you compare the sun to other stars that are in our galaxy, it is actually fairly small. The image below shows you the relative sizes of the planets and some well known stars:

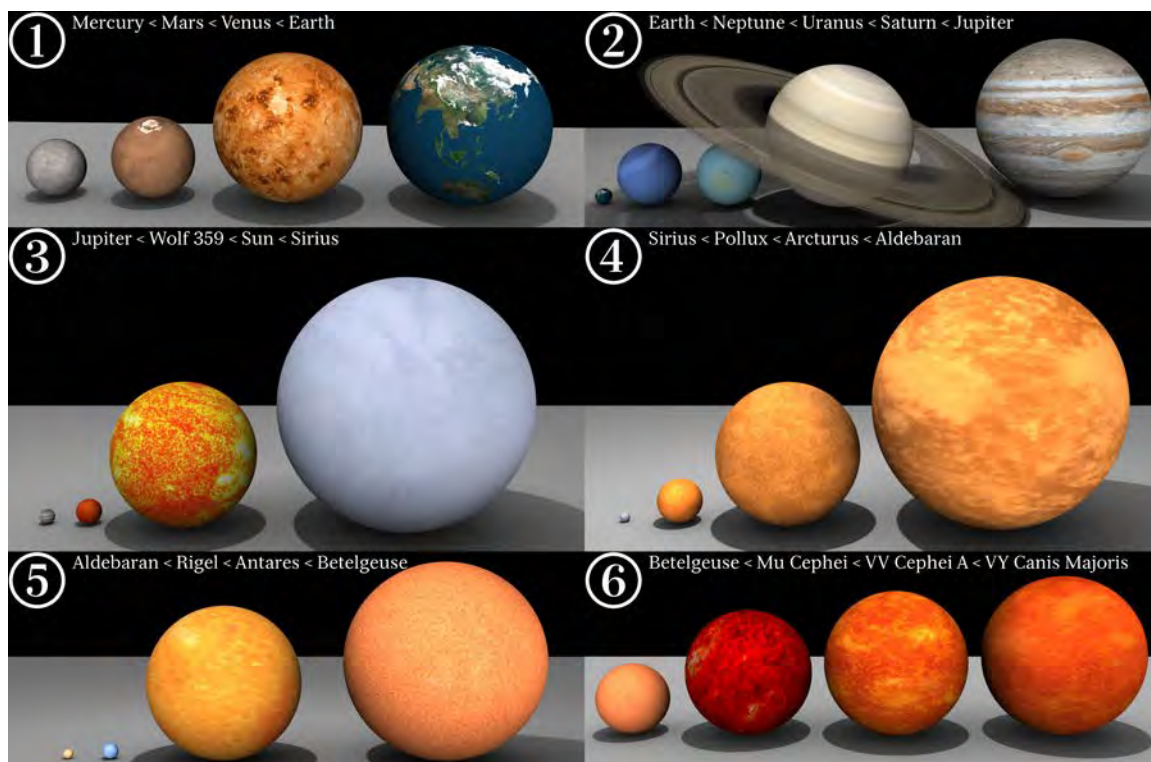

*Relative sizes of planets and stars, Wikipedia, Dave Jarvis, 2008*

Our sun formed in the same way that all the other stars formed from the collapse of an interstellar gas cloud. Let's take a look at how this happens.

### How Stars are Born

A nebula is a gigantic area of dust and gas that is found in outer space. Stars form from collapsing clouds of interstellar dust and gas (mostly hydrogen and helium). As the cloud falls in on itself under its own weight, it will get hotter and hotter as more dust and gas gets packed

together. Over millions of years the cloud will get hot and it will contain so much gas and dust that it will start to burn and generate visible light.

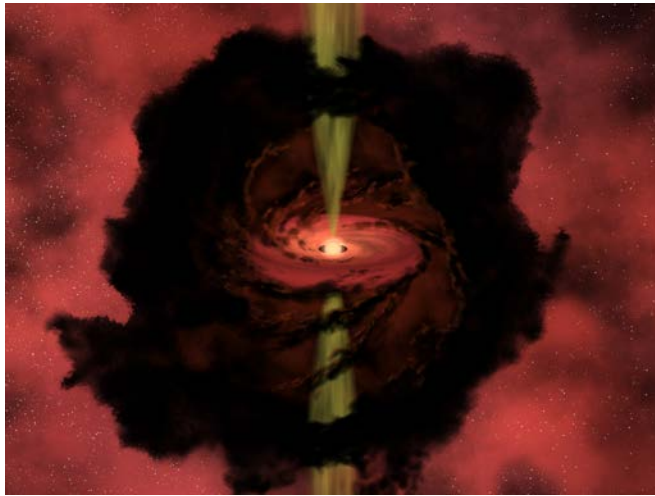

*Artist's interpretation of star formation, Wikipedia, NASA, 2006*

A prime example of a place in outer space where thousands of stars are being born is called the Orion Nebula. It's called the Orion Nebula because it is located in the Orion constellation.



*Orion Nebula, a star nursery, courtesy of Tenho Tuomi, 2008*

The Orion Nebula is readily visible with a reasonably powered telescope and is a wonderful sight in the winter months when the Orion constellation is visible.

## How Stars Live

Stars are mostly made up of two elements, hydrogen and helium. At the centre of a star, there is a whole lot of hydrogen that is extremely hot. The centre of the sun is 15 million degrees Celsius! At such extreme temperatures, hydrogen can start to burn and is converted into helium. During this conversion from hydrogen to helium, light is released. The light gradually makes its way from the core of the star to the surface and then is released out into space. The sun is responsible for providing light to the solar system. If it were not for the hydrogen reactions taking place at the centre of the Sun, there would be nothing to provide consistent light and warmth to the Earth. The sun has been burning for the last 4.5 billion years and contains enough hydrogen fuel to keep burning for another 4.5 billion years, so we don't have to worry about the sun burning out any time soon!

## How Stars Die

All stars are born, and will eventually die as they run out of fuel. The death of a star depends on its mass. The bigger a star, the more cataclysmic its death will be. The sun is a mid-range star, it is not especially big and not especially small. In roughly 4.5 billion years the sun will exhaust all of its hydrogen fuel. This will cause the sun to expand out like a balloon and will become what astronomers call a red giant star. A red giant is essentially an expanding shell of star material and at the centre of this expanding shell is a dead star called a white dwarf. Over time a red giant will turn into a planetary nebula as the material spews out into space. There are many stars out there that we can observe that are already at their red giant phase. Betelgeuse in the constellation Orion is an example of a red supergiant star because it is extremely large.

*Arrow pointing at the red supergiant star, Betelgeuse, WikiCommons, Hubble ESA, 2009*



Very massive stars will die in explosive ways. A supernova explosion is what happens when a supermassive star exhausts all of its hydrogen fuel. Instead of expanding out at a slow rate like a red giant, all the material that is in the supermassive star will collapse in on itself, rebound off its core and blow out in all directions. This happens extremely fast and the material can expand out at speeds of up to 30,000 kilometres per second! An example of a supernova remnant that you can see with a reasonably powered telescope is the crab nebula. This supernova was observed in 1054 A.D. by Chinese astronomers and was bright enough to be seen in broad daylight! The supernova has been dimming ever since:



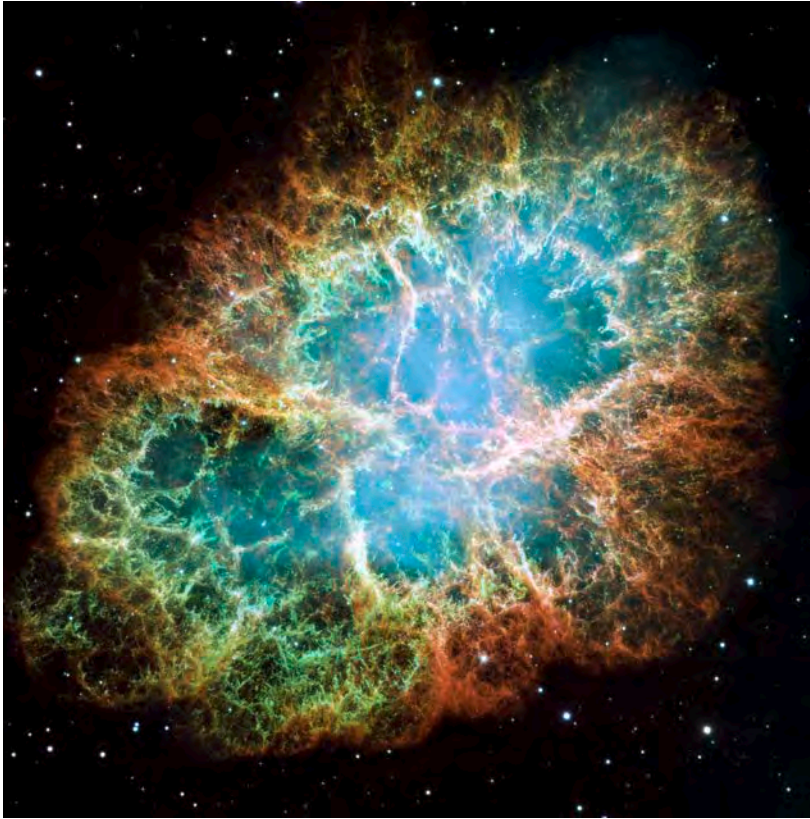

*Crab Nebula, Wikipedia,  
NASA, ESA, J. Hester and A.  
Loll, 2005*

At the centre of a supernova remnant is what astronomers call a neutron star. A neutron star is an incredibly dense, dead star. In some cases, a star will be large enough that it will collapse in on itself and a black hole will be created. A black hole is an area of space where the gravitational field is so strong that not even light can escape, hence the name “black hole”.

## Different Types of Stars

All stars are a little unique in their own way. When you look at the stars you will see that they come in all different sizes and colours. Some are white, others blue, others might be red or yellow. The colour of a star depends on its temperature and also what it is made of. Most stars have a very similar composition but there are trace differences that will cause a slight colour difference. The main aspect that determines a star's colour is its temperature. A blue or white star is burning at a higher temperature than a yellow or red star. A red giant is a star that is near the end of its life and has started to shed its outer layers and cool off. Betelgeuse is a star in the constellation Orion and is an example of a red giant star. When you observe Betelgeuse it will be red in colour.



*Betelgeuse in Orion, Wikipedia, NASA, 2002*

On the other hand, Vega in the constellation Lyra is a bluish-white coloured star that is midway through its lifespan. Vega is steadily burning hydrogen in its core and is very hot, as indicated by its colour.

*Vega in Lyra, Wikipedia, Drew Farwell, 2013*



The size of a star depends on how much space it takes up but also on how far away it is. A very large star may appear small if it is extremely far away. Conversely, a relatively small star may

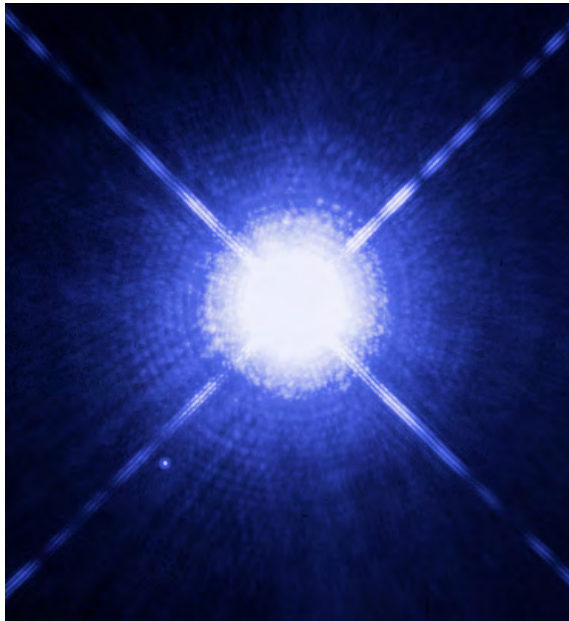

appear large if it is quite close. Sirius, a star located in the constellation Canis Major, is the brightest star in the entire night sky. The reason it is so bright is first that it is burning very hot as demonstrated by its bluish-white colour. Additionally, Sirius is only 8.6 light years away from the Earth, making it one of Earth's nearest star neighbours.

*Sirius in Canis Major, Wikipedia, NASA, 2003*

## Finding Stars to Observe with your Telescope

You may be surprised to know that many of the stars that you see in the night sky are actually double stars. In other words, when you look at a star with your naked eye it may appear to be a single star, but when you point a telescope to it, you can actually make out two stars. The reason that stars are often double is because they are gravitationally attracted to each other. Similar to how the Earth is orbiting around the Sun, two stars can orbit around each other. A binary star system is what we call two stars that are gravitationally locked together in orbit.



A star may only appear to be a single star because your eyes aren't sensitive enough to resolve the two stars. A good example of this is the star Albireo. Albireo is a star in the constellation Cygnus, the Swan. The star Albireo makes up the head of the swan and when you look at Albireo with your naked eye it appears as a single star.

*Unresolved double star Albireo in Cygnus, Wikipedia, Henryk Kowalewski, 2006*

When you point a telescope towards Albireo you can resolve it into two separate stars called Albireo-A and Albireo-B. The stars together make up one of the best binary star systems to look at because the stars have an amazing colour contrast. When you look at Albireo through a telescope, even with low magnification, you'll notice that Albireo-A is bigger and yellow in colour, whereas Albireo-B is smaller and slightly blue, as shown here:



*Double star Albireo in Cygnus resolved with a telescope, Wikipedia, Jim Spinner, 2004*

Not all stars in the sky are double stars but many are and that makes looking at stars quite interesting. There are also many other stars that are single that are also interesting to look at with your telescope.

The following is a list of some great stars and star systems to observe with or without a telescope. Refer to chapter four if you would like to refer to the star charts to locate these stars.

<b>Name of Star or Star System</b>	<b>Constellation</b>	<b>Magnitude</b>	<b>Description</b>
Albireo	Cygnus	3.1	Double star, colour contrast
Alcor and Mizar	Ursa Major	2.2	Quadruple star system
Arcturus	Bootes	-0.04	Orange giant star
Spica	Virgo	1.0	Blue giant star
Sirius	Canis Major	-1.5	Brightest star in night sky
Betelgeuse	Orion	0.42	Red giant star
Vega	Lyra	0.03	Bright, blue-tinged star
Almach	Andromeda	2.3	Double star, colour contrast
Castor	Gemini	1.9	Double star

## Chapter 8 What Else is Out There?

---

### Galaxies

It wasn't until the early 20<sup>th</sup> century that scientists began to realize how big the universe really is. Up until the 1920s most astronomers believed that the universe did not extend beyond the Milky Way Galaxy. Today, we know that the universe is unimaginably huge and it contains billions upon billions of galaxies, with each galaxy containing billions of stars:

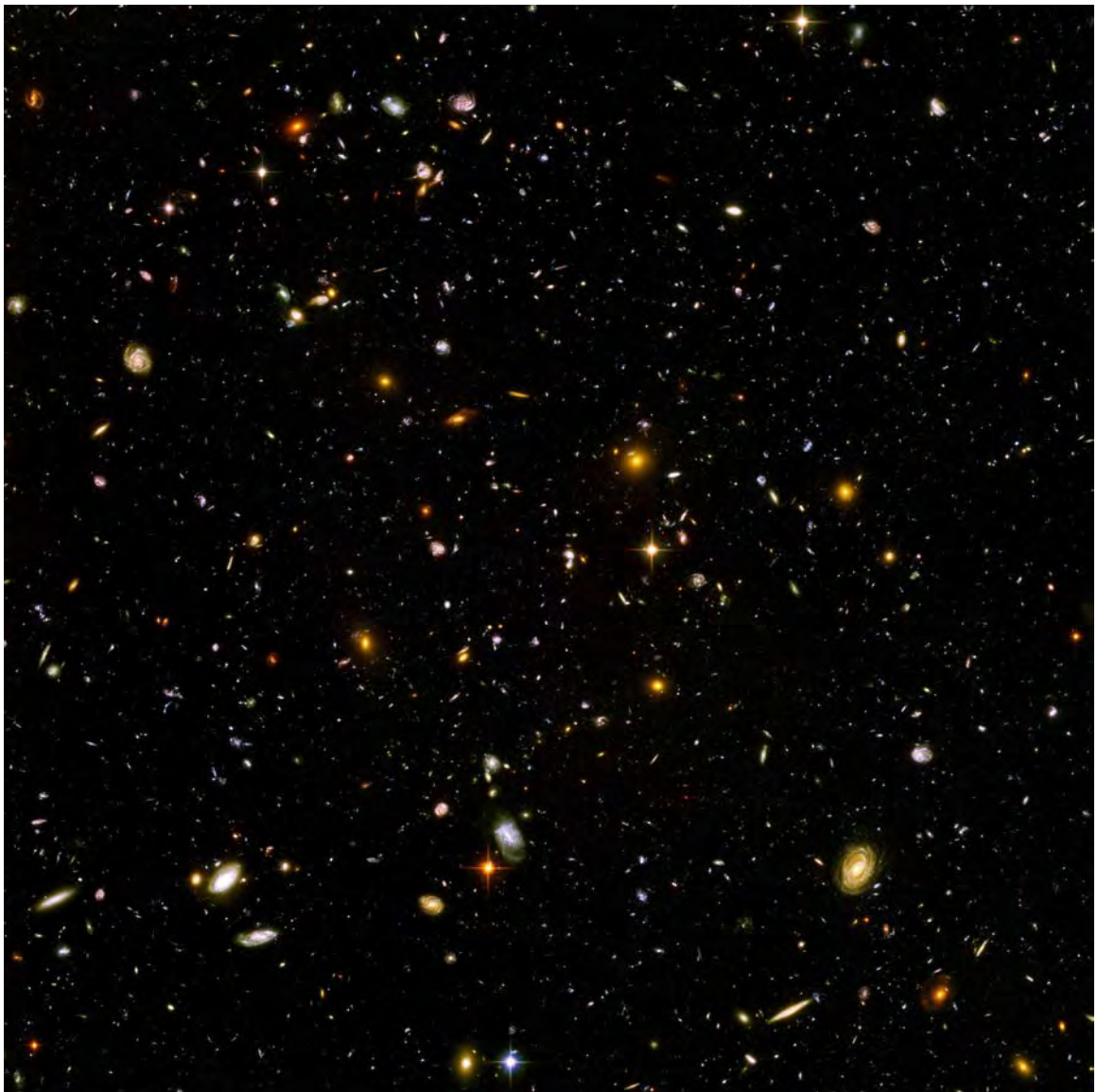

*Hubble Ultra Deep Field, WikiCommons, HubbleSite, 2004*



One interesting aspect about galaxies is that they are attracted to each other by gravity, the same way that the planets are attracted to the sun by gravity. If two galaxies were to cross paths there is nothing stopping them from colliding with one another. Galaxy collisions are occurring right now in the universe. Here is a series of images that are pictures taken of some galaxy collisions in our universe:

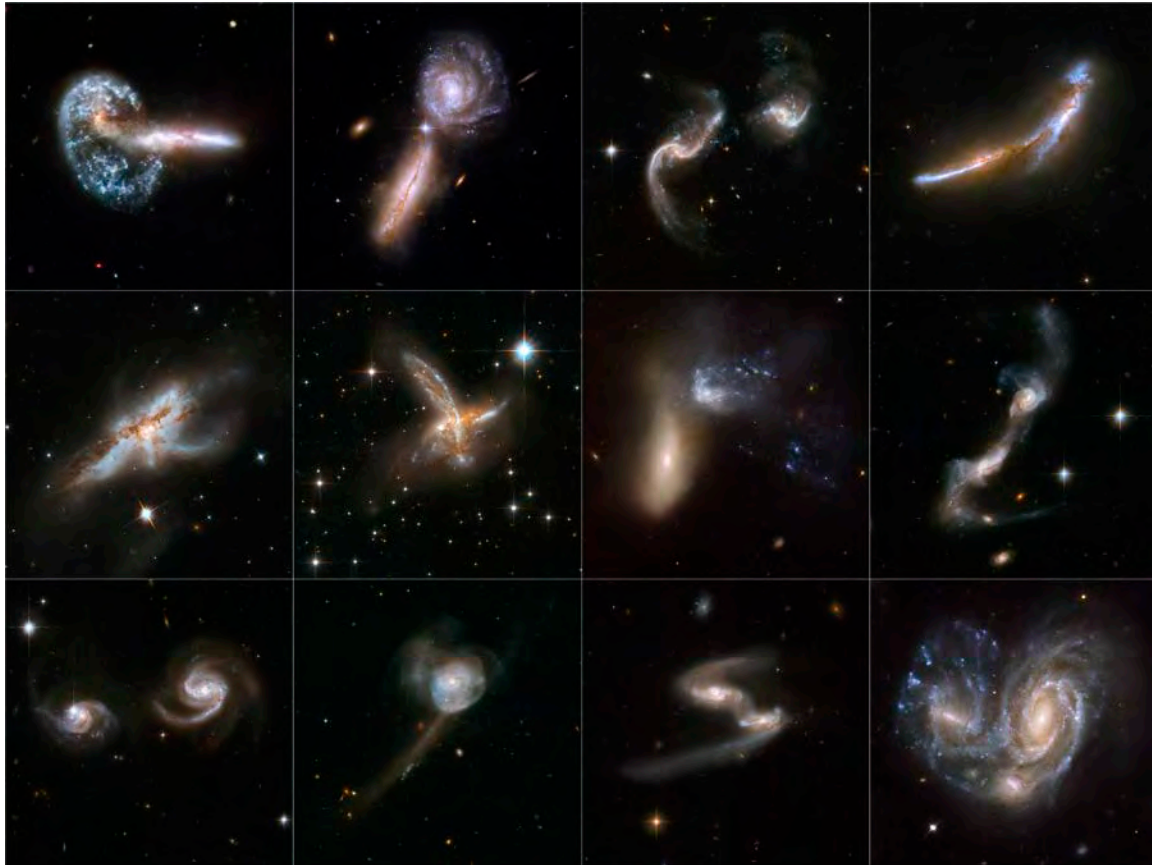

*Galaxy collisions, WikiCommons, HubbleSite, 2008*

The Andromeda Galaxy is the closest galaxy to the Milky Way. Astronomers have figured out that Andromeda and the Milky Way are headed toward each other and will collide in roughly 4 billion years. This may sound like a cataclysmic event but the interesting thing is that there is so much space between every star that star collisions are very rare during galaxy collisions. So if humankind happened to be around in 4 billion years it may be a spectacular event. Below is an artist's interpretation of what it might look like from Earth once the Andromeda Galaxy gets close to our own:



*Andromeda Galaxy collision with Milky Way, WikiCommons, NASA, 2013*

Some galaxies are readily visible with a telescope, binoculars or even with your naked eye. Later in this section we will see where you can find some prominent galaxies in the night sky.

## Star Clusters

Star clusters are exactly what they sound like, clusters of stars. The stars within a star cluster are gravitationally attracted to one another which is why they stay together. Star clusters form within an interstellar gas cloud and because the stars formed at roughly the same time they are all similar in age.

Star clusters are classified as either open star clusters or globular star clusters. The difference is that open star clusters generally have fewer stars that are more spread out. Globular clusters can have hundreds of thousands of stars that are relatively close together. One of the more famous open star clusters is the Pleiades, also known as the Seven Sisters or M45. The Pleiades is found in the constellation Taurus and is one of the closest star clusters to Earth, making it very easy to see with your naked eye.



*Pleiades star cluster courtesy of Dick Kirk*

An example of a well known globular star cluster is the Great Hercules Cluster also known as M13. This cluster is made up of roughly 300,000 stars that are gravitationally attracted to one another and is located in the constellation Hercules.



*Great Cluster of Hercules, M13, courtesy of Tenho Tuomi, 2007*

## Nebulae

The word “nebula” actually comes from the Greek word for “cloud”. A nebula (plural nebulae) is a cloud of dust and gas that can be found in the space between the stars. Nebulae come in all different shapes, sizes, colours, temperatures and will form in different ways. A nebula will also “light up” for different reasons. A reflection nebula is a cloud of dust and gas that reflects light from a nearby star, causing the cloud to glow. An emission nebula is a cloud of dust and gas that has a very high temperature and will absorb and re-emit light from a nearby star, causing the cloud to glow. Star formation often occurs in emission nebulae and the newly formed stars are the source of light that allow the cloud to glow. Finally, a planetary nebula is a cloud of dust and gas that formed from the death of a star. The remaining material is hot enough to emit light, similar to an emission nebula. Here are some images of some common nebula that are visible with a modestly powered telescope:

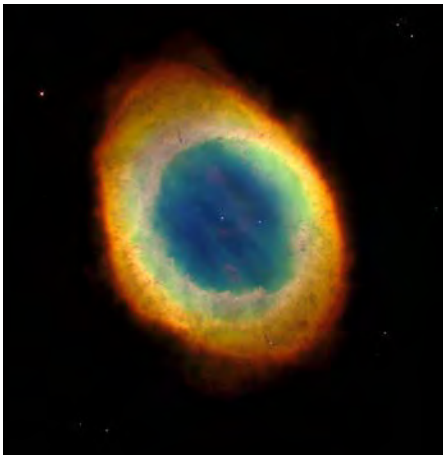

*Ring Nebula, M57, Wikipedia, Hubble, 1998*

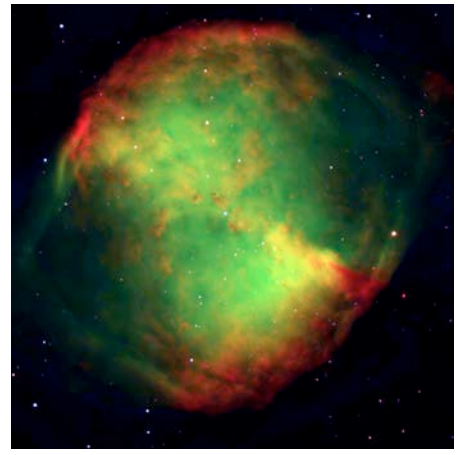

*Dumbbell Nebula, M27, Wikipedia, ESO, 1998*

*Orion Nebula, M42, Wikipedia, NASA, Hubble, 1998*



## Finding Galaxies, Star Clusters and Nebulae with your Telescope

When we talk about galaxies, star clusters and nebulae we call these deep sky objects because they are very far away from the solar system. There are many deep sky objects that people can find throughout the year, whether you are using binoculars, a telescope or even your naked eye. As we saw before, seasonal constellations are only up for part of the year due to the Earth orbiting the sun. If a deep sky object is found within a constellation that has set for the year, we will have to wait until that constellation is up again before we can see that object. Many deep sky objects are only visible for part of the year. The following is a list of objects with their corresponding magnitudes and constellations that you can find them in. Below the table you can find a corresponding constellation map that shows you where each of deep sky objects are located:

Object	Description	Magnitude	Constellation	Season Visible	Visible with Naked Eye?
M1 – Crab Nebula	Supernova remnant	8.2	Taurus	Winter	No
M11– Wild Duck Cluster	Open star cluster	6.3	Scutum	Summer	No
M13 – Hercules Cluster	Globular cluster	5.8	Hercules	Summer	No
M27 – Dumbbell Nebula	Planetary nebula	7.5	Vulpecula	Summer	No
M31 – Andromeda Galaxy	Nearby spiral galaxy	3.4	Andromeda	Fall	Yes
M42 – Orion Nebula	Emission nebula	4.0	Orion	Winter	Yes
M44 – Beehive Cluster	Open star cluster	3.7	Cancer	Spring	Yes
M45 – Pleiades	Open star cluster	1.6	Taurus	Winter	Yes
M57 – Ring Nebula	Planetary nebula	8.8	Lyra	Summer	No
M81 – Bode’s Galaxy	Spiral galaxy	6.9	Ursa Major	Any	No
NGC 869/884	Double open star cluster	3.7	Perseus	Fall	Yes



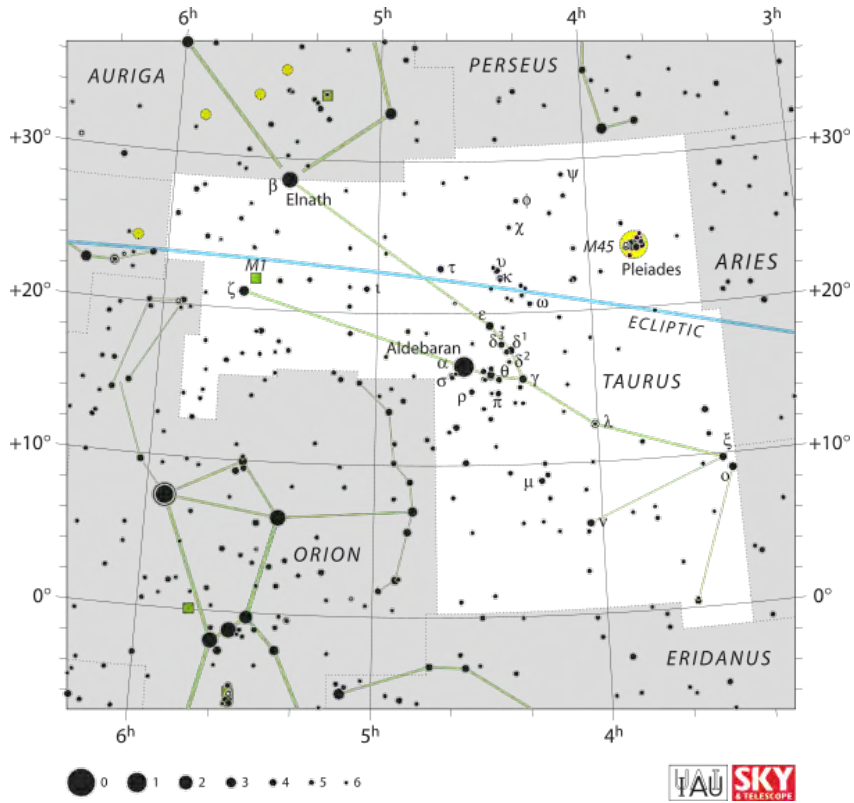

Location of M1 and M45 in Taurus, Wikipedia, IAU and Sky & Telescope magazine, Roger Sinnott & Rick Fienberg

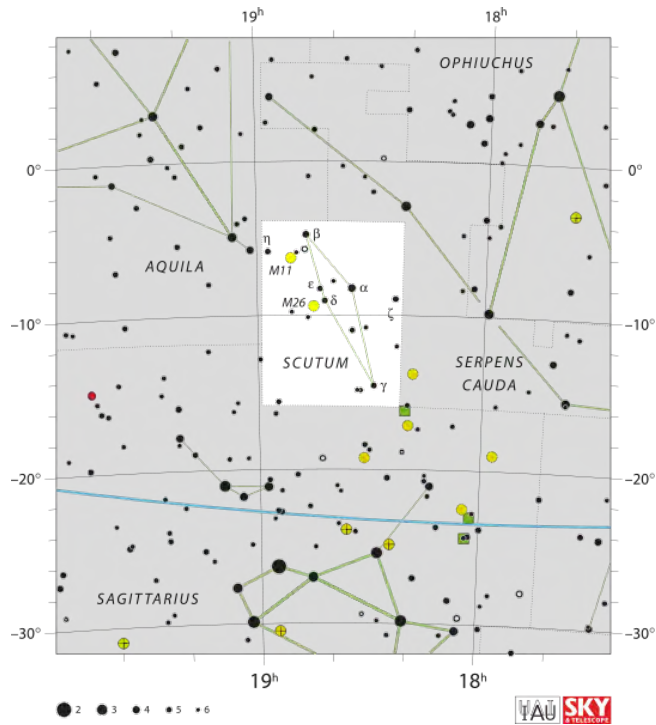

Location of M11 in Scutum, Wikipedia, IAU and Sky & Telescope magazine, Roger Sinnott & Rick Fienberg

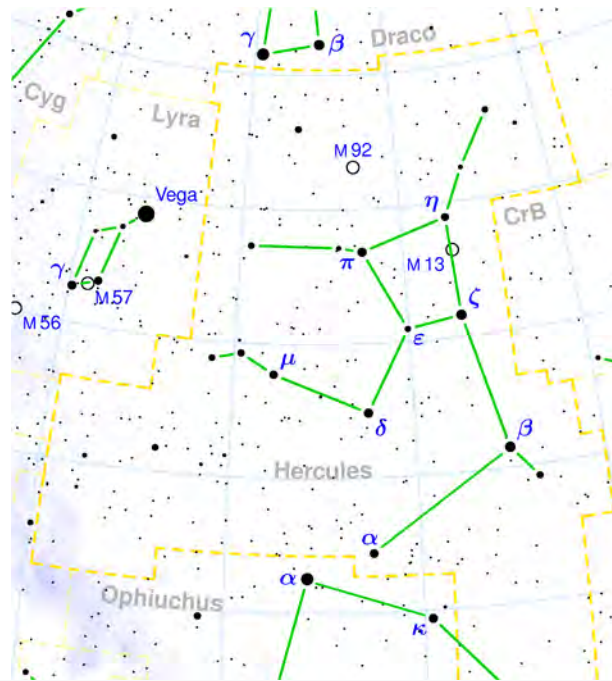

Location of M13 in Hercules, Wikipedia, IAU and Sky & Telescope magazine, Roger Sinnott & Rick Fienberg

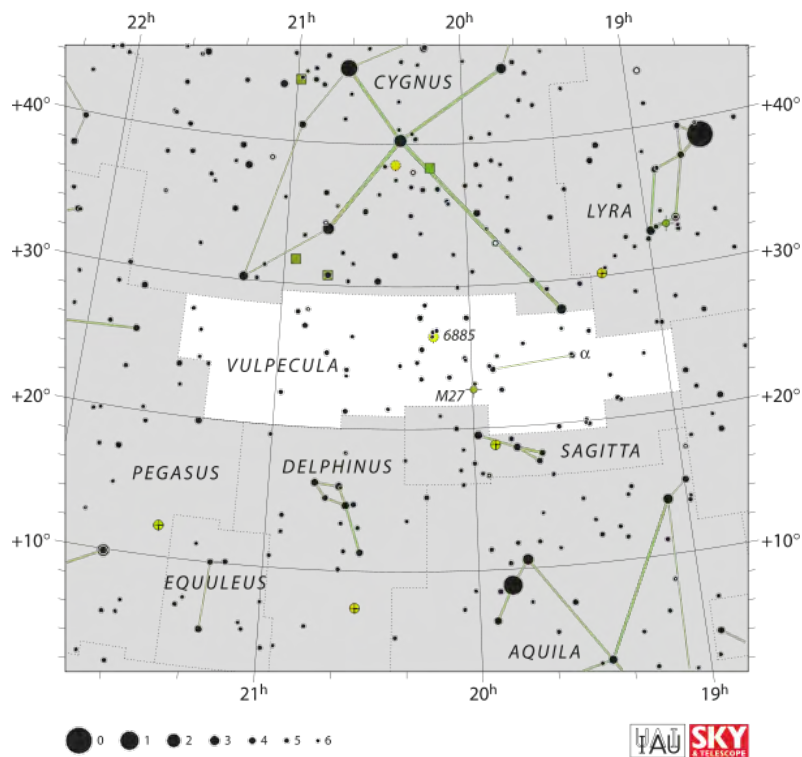

Location of M27 in Vulpecula, Wikipedia, IAU and Sky & Telescope magazine, Roger Sinnott & Rick Fienberg

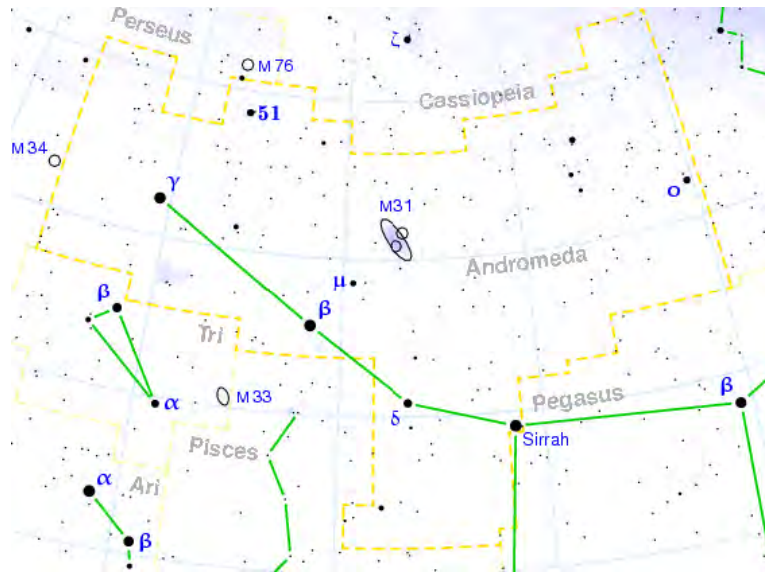

Location of M31 in Andromeda, Wikipedia, Bronger, 2005

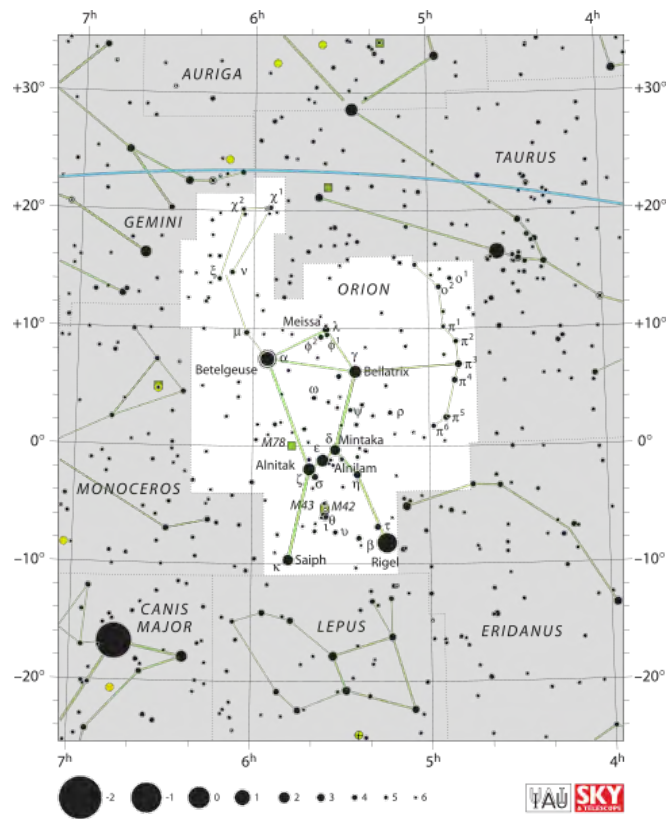

Location of M42 in Orion, Wikipedia, IAU and Sky & Telescope magazine, Roger Sinnott & Rick Fienberg

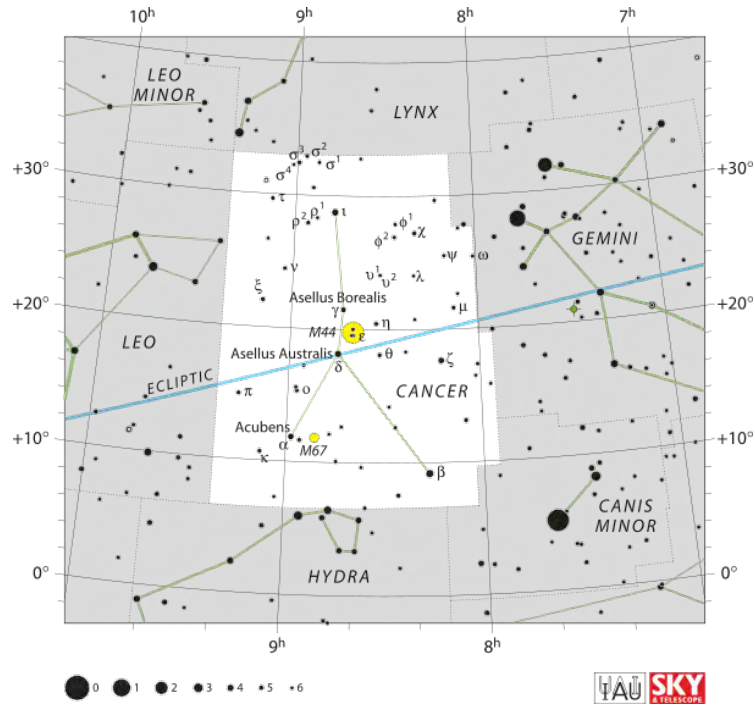

Location of M44 in Cancer, Wikipedia, IAU and Sky & Telescope magazine, Roger Sinnott & Rick Fienberg

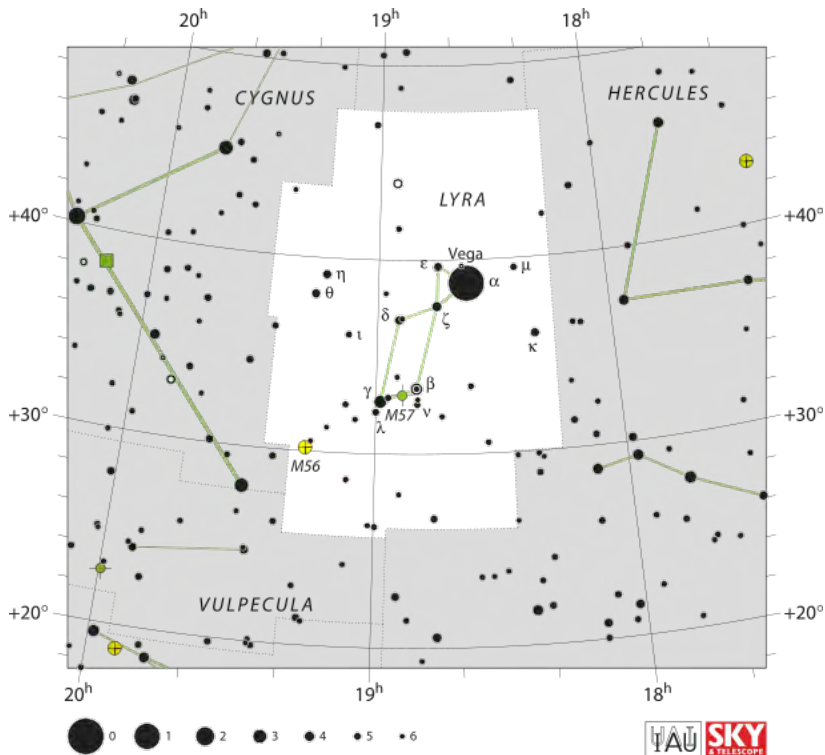

Location of M57 in Lyra, Wikipedia, IAU and Sky & Telescope magazine, Roger Sinnott & Rick Fienberg

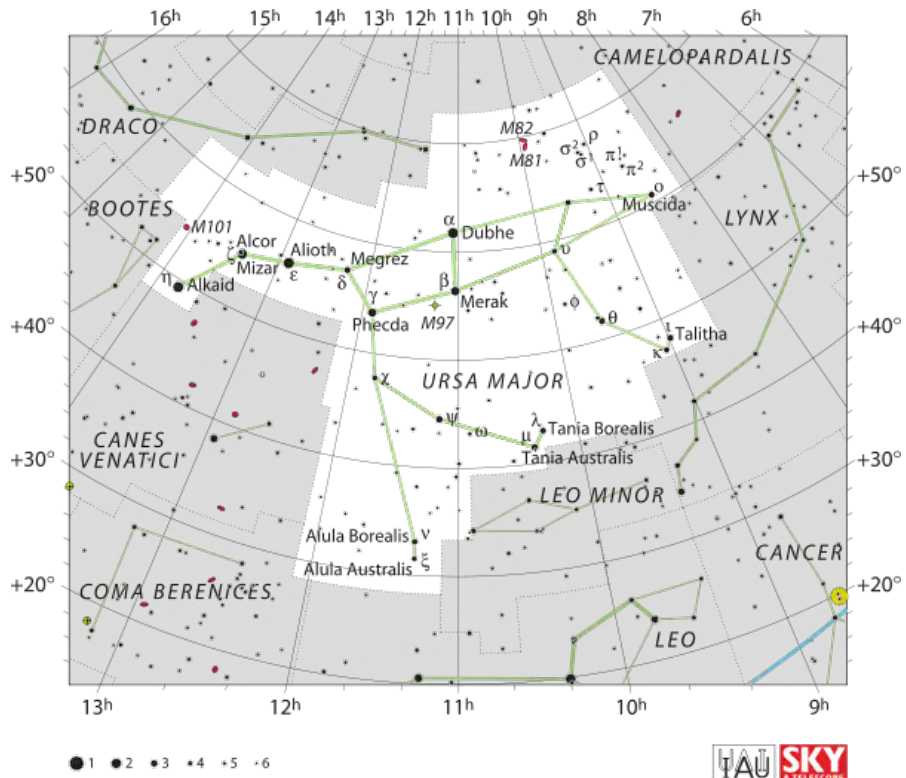

Location of M81 in Ursa Major, Wikipedia, IAU and Sky & Telescope magazine, Roger Sinnott & Rick Fienberg

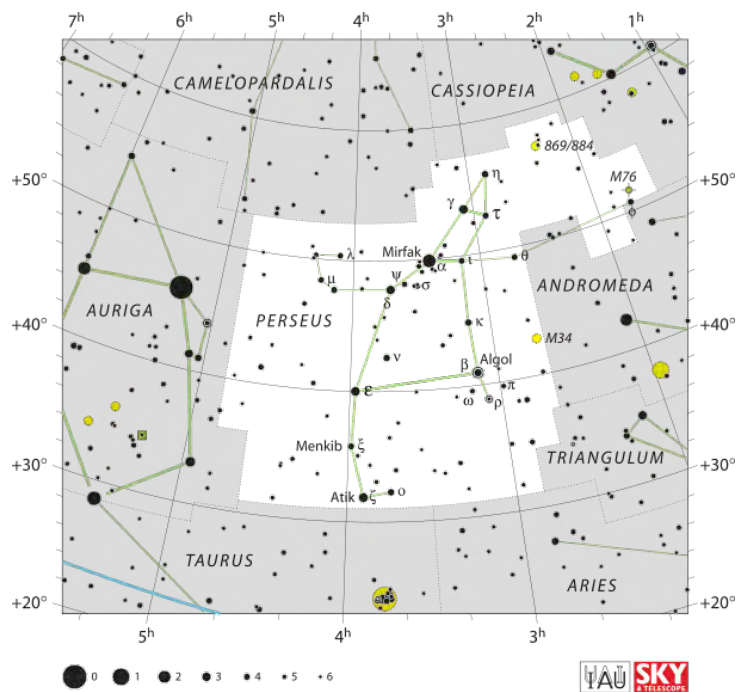

Location of NGC 869/884, Wikipedia, IAU and Sky & Telescope magazine, Roger Sinnott & Rick Fienberg



# Chapter 9 Astronomy and Agriculture

## Constellations and Agriculture

As mentioned in chapter four, the constellations have had a mythological significance to ancient civilizations but they have also been used extensively for navigation. The patterns in the sky were easily recognizable to ancient people and allowed them to tell the time of year. This was very useful when it came time to think about planting seeds or harvesting crops. In the northern hemisphere, if the Orion constellation was visible it was an indication that winter was soon approaching. If the summer triangle was visible it meant that summer was just around the corner. Today with calendars being readily available we no longer use the constellations for this purpose, but in the past, knowing the constellations was a vital part of the practice of farming.

## Seasons and the Sun

First Nations people were the first in Canada to understand how the seasons would affect their capacity for growing crops. People adapted to the harsh winters and hot summers of Saskatchewan and it was very helpful to track the patterns in the stars in order to know when to expect the change in seasons. So what exactly causes the seasons? And why don't places near the equator experience winter while the North and South Poles experience perpetual winter? The answer has to do with the position of the sun in the sky. In the winter months we see less of the sun because it is lower down towards the southern horizon. In the summer months we see more of the sun since it is higher in the sky above the southern horizon.

The reason that the sun is higher in the sky in the summer has to do with the tilt of the Earth combined with the fact that it is orbiting the Sun. Recall that the Earth has an imaginary line running through the North Pole to the South Pole called its rotation axis. The rotation axis of the Earth is tilted relative to its orbit at 23.5 degrees.

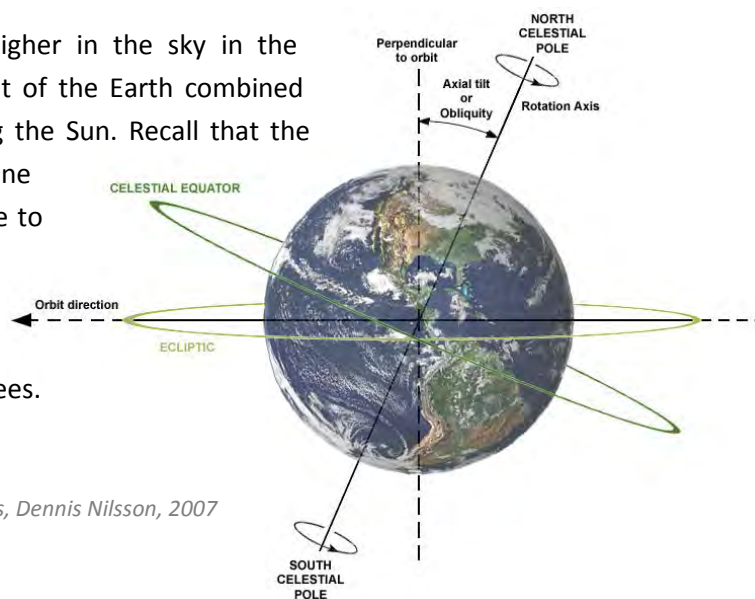

*WikiCommons, Dennis Nilsson, 2007*

The Earth is tilted as it orbits the Sun. As a result, for half of the year one half of the Earth will be more exposed to sunlight compared to the other half:

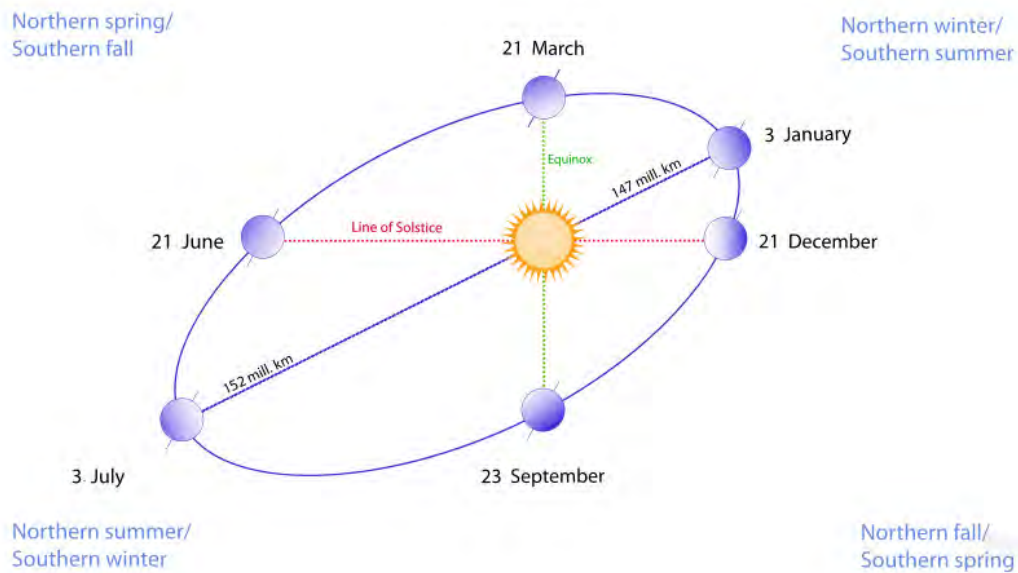

*Orbit of the Earth around the Sun, Wikipedia, Gothika, 2010*

During northern summer, the Earth will have more concentrated sunlight exposed on the northern hemisphere and the sun will appear higher in the sky. Northern summer actually occurs when the Earth is farthest away from the Sun. During northern winter, the Earth will have less concentrated sunlight exposed on the northern hemisphere and the sun will appear lower in the sky:

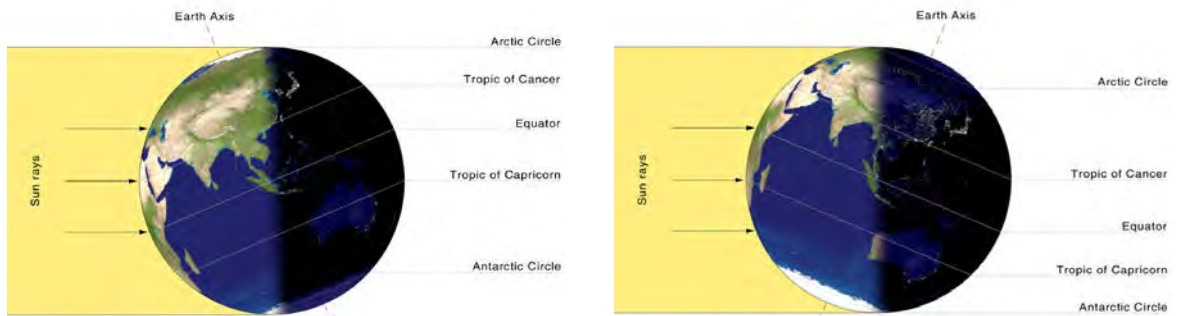

*Northern Summer, Wikipedia, Blueshade, 2005*

*Northern Winter, Wikipedia, Blueshade, 2005*

At the equator there is always a high concentration of light throughout the entire year, so the seasons are not as drastic of a change at the equator and it generally remains quite hot. Likewise at the North and South Poles, there is always a low concentration of light throughout the entire year, so it always remains very cold. Throughout summertime at the North Pole, the sun will never set during the months of April – September just as the wintertime at the North

Pole the sun will never rise during the months of October – March. The same is true for the South Pole except with the months reversed.

## Observatories in your Area

It's important to realize that there are observatories all over the place and you may not even realize it. Keep your eyes and ears open, do a little research online and you may be surprised to find out what is going on in terms of astronomy in your local community. Often you can gain access to an observatory either by joining an astronomy club like the RASC which would allow you to borrow or use telescope equipment, or it's often the case that an observatory will have an open house that welcomes the public to stop by and view the stars. The University of Saskatchewan Campus Observatory, for example, is open every Saturday evening for an open house where the public can go and view any objects that are up in the sky at that time of year. Here is a link to a promotional video on the U of S Campus Observatory: <http://www.youtube.com/watch?v=oD-7FbjjUoo>

To find out more about observatories in your area, check out <http://www.rasc.ca/observatories>. The RASC has listed a number of facilities that have public outreach and research programs across Canada.

## Dark Sky Areas

As cities continue to grow into rural areas it is getting harder and harder to find areas that are not bathed in light pollution. The problem of light pollution goes beyond astronomers not being able to see the stars. There are issues regarding stress on wildlife and insect populations for example, so the issue of light pollution is also an environmental problem. Some groups of people in the country have taken the initiative to push their cities to make smart choices when installing light fixtures that are made to preserve dark night skies. There are many areas across the country that have been designated as "Dark Sky Preserves", where there are strict guidelines on the installation of light fixtures. For example, Saskatchewan's Cypress Hills Interprovincial Park as well as the Grasslands National Park have both been designated as Dark Sky Preserves by the Royal Astronomical Society of Canada. This is an important step in preserving our night skies so that future generations can indulge in their magnificence.

To find out more about areas that have been designated as dark sky preserves by the RASC, check out <http://www.rasc.ca/dark-sky-site-designations>. The RASC has listed a number of dark sky preserves across Canada.

## Royal Astronomical Society of Canada

The Royal Astronomical Society of Canada (RASC) is a national organization dedicated to the promotion of astronomy and stargazing. Most large centres have a chapter and will host star parties and special events throughout the year related to viewing astronomical objects. Anyone is welcome to join the RASC for a modest annual price. If you have questions regarding anything related to astronomy, members of this organization are happy to help. Check out the national RASC website at [www.rasc.ca](http://www.rasc.ca).

# Chapter 10 Careers in Astronomy

---

## How to Become an Astronomer

Everyone is an Astronomer at heart. We have all looked up at the night sky and seen the stars, the Moon, the planets and perhaps the Milky Way. Seeing these objects draws on our curiosity about the universe. For some people this is not enough; they want to learn more and spread the joy of astronomy to others. In practice, there are amateur astronomers and professional astronomers. Amateur astronomers generally don't get paid for their work, but they have a driving passion for learning more about the universe. Professional astronomers work full-time in studying, problem solving, researching and teaching particular aspects of astronomy and dedicate much of their lives to this work.

### Amateur Astronomers

One of the best ways to get started in becoming an amateur astronomer is to get involved with a local community of astronomers. Larger centres in Canada will have an amateur astronomy club, likely associated with the Royal Astronomical Society of Canada (RASC). The RASC will sometimes hold star parties where members will set up their telescopes on a clear night and the public is welcome to view celestial objects through the telescopes. This is a great opportunity for people to get involved and start a path toward becoming an amateur astronomer. Often by becoming a member of the RASC you will enjoy the benefits of renting a telescope from your local chapter, which some people prefer to do rather than buy a brand new telescope.

There is plenty of information online and at your library that can get you started in becoming an amateur astronomer. Find what you are interested in and run with it. Be aware that you don't need to spend piles of money to become an amateur astronomer, it is important to find out what is going on in your community and to think about your goals around astronomy.

### Professional Astronomers

Professional astronomers work full-time by conducting research in astronomy, teaching others about Astronomy, or coming up with new techniques to understand the universe. Generally if you want to become a professional astronomer you will have to pursue some level of post-secondary education. There are many programs in Canada that offer undergraduate, graduate and PhD programs in astronomy or related fields. With technological advances and new areas of research emerging related to the discovery of planets, finding life in the universe and understanding how our universe is evolving, there are a variety of opportunities for people of all interests to study the stars.



## What do Astronomers do?

Astronomers want to find out more about the universe. Astronomers are interested in finding new stars and planets, understanding the properties of galaxies, star clusters and nebulae, as well as understanding how the universe formed and how it will evolve over time. Modern astronomy relies on disciplines like physics, mathematics, chemistry, engineering, and even biology and geology. Some astronomers are interested in learning more about the origin and evolution of life in our universe, an emerging discipline called astrobiology. Astrobiologists want to learn what conditions are needed for life to start on a planet.

Some astronomers work long hours overnight because a lot of the work has to be done when the stars are up in the sky. Solar astronomers can work during the day as they are studying the Sun. Likewise, radio astronomers can work during the day because visible daylight does not impede their viewing conditions. Some astronomers decide that they want to work for a space organization like Canadian Space Agency or NASA, that sends satellites and space telescopes into the outer limits of the solar system. Other people interested in astronomy might be focused on sharing their knowledge with the younger generation through teaching in the school system or at a university.

There is a huge diversity in the field of astronomy and a huge variety of careers to consider. If you are interested in astronomy there are many possible career paths as listed below:

**Teacher** – Spread the joy of astronomy by teaching in the school system or at a university. Teachers in the school system generally need to go to university to finish a teaching degree and then they can apply for teaching certification. If you want to teach at a university you generally need a Masters degree or PhD.

**Professor** – If you want to do research in astronomy as well as teach then becoming a professor may be right up your alley. Professors have a primary research interest and when they are not researching they are teaching students in university classes. Professors generally have a bachelors and masters degree as well as a PhD. Some of the fields that are being researched by professors at various colleges and universities are:

**General Astronomy** – Some researchers have a broad interest and want to study many different aspects of astronomy ranging from the solar system to galaxies and the universe.

**Radio Astronomer** – Radio astronomers focus on doing research with radio telescopes. In other words they use telescopes to analyze objects that are emitting radio wavelengths of light.

**X-ray Astronomy** – X-ray astronomers focus on doing research of x-ray sources. In other words they use telescopes to analyze objects that are emitting x-ray wavelengths of light.

**Solar Astronomer** – Solar astronomers are primarily interested in studying the sun. There is a lot we do not know about the sun and researchers are learning more every day.

**Planetary Astronomer** – Planetary astronomers are interested in discovering new planets and understanding how planets form and evolve over time.

**Stellar Astronomer** – Stellar astronomers are interested in how stars form, how they live and die.

**Galactic Astronomer** – Galactic astronomers are interested in how galaxies form and evolve over time.

**Cosmologist** – Cosmology is the study of the universe as a whole. Cosmologists are interested in how the universe began, how it is evolving over time and how the universe will end.

**Neutrino Astronomer** – Neutrinos are extremely small particles of matter that are being emitted by astronomical objects like the sun and stars. Neutrino observatories exist that are dedicated to detecting these tiny particles of matter.

**Astrobiologist** – Researchers interested in astrobiology are concerned with locating planets or moons that may contain life. Also a main goal is to understand what conditions are necessary for life to exist on a planet or moon.

**Astrophysicist** – An astrophysicist is someone that wants to understand the physics of the universe. Astrophysics is integral to almost any discipline in astronomy because it lays the foundation for understanding the structure of the solar system, stars, the galaxy and the universe as a whole.

**Researcher/Technologist** – You do not have to be a professor if you are interested in doing research. Some people work in astronomy labs at universities or space agencies after completing a degree in astronomy, physics, engineering or a related discipline.

**Public Outreach** – If you are more interested in educating the public about astronomy rather than researching then you may want to think about a career in public outreach. There are observatories, universities and other organizations that hire individuals to teach the general public about astronomy through guided tours, developing activities and displays and giving presentations.

**General Engineer/Flight Engineer** – If you are interested in building things, problem solving and putting things together then you may want to consider a career in engineering. Space agencies, engineering firms, universities and other organizations are generally looking for skilled engineers to research, develop and build the technology needed in space exploration.

**Astronaut** – Have you ever dreamed of going to space and working on a space station? Are you interesting in space flight and piloting an aircraft or spacecraft? Many astronauts start out as flight engineers, pilots or scientists and eventually work their way into space flight. Becoming an astronaut is an ambitious goal and a lifelong endeavour, but it should certainly be considered if you have an interest.

**Computer Engineer/Programmer** – There is no doubt that computer programmers are in high demand in virtually any field these days related to science or technology. If you are interested in computers and making computer systems run properly then you may want to consider a career in computer engineering or programming.



*Chris Hadfield, Retired Astronaut,  
Wikipedia, NASA/Robert Markowitz, 2011*



*Aircraft Technician, Wikipedia, Israel Defense Forces, 2010*



*Engineering Technicians, Wikipedia, Noel Hepp, 2009*



*Very Large Array (radio telescopes), Wikipedia, Hajor, 2004*



*Carl Sagan, Astronomer and Public Educator,  
Wikipedia, NASA/JPL*

# Glossary of Definitions

---

**Annular eclipse** – A solar eclipse where the moon is a bit too far away for the umbra to reach the Earth, this causes the outer edge of the sun to be visible around the moon.

**Antumbra** – The part of a shadow that allows the outer edge of the sun to be visible around the moon during a solar eclipse.

**Aperture** – The diameter of a telescope's objective lens or primary mirror. The aperture determines the light gathering power of a telescope. A more powerful telescope will have a larger aperture.

**Asterism** – A pattern of stars in the sky.

**Asteroid** – A small solar system object that orbits the sun and is irregular in shape. Asteroids are mostly made of rock and ice.

**Astrology** – A subject that assumes there is a connection between astronomical phenomena and human life. Astrology is not a science.

**Astronomy** – A subject dealing with the study of celestial objects such as galaxies, stars, planets, moons and nebulae. Astronomy attempts to understand our place in the universe from a scientific perspective.

**Axis** – An imaginary line that passes through the north pole and out the south pole of the earth. The Earth completes one rotation around the axis in 24 hours.

**Black hole** – An area of space where the gravitational field is so strong that not even light can escape. Black holes are created by the deaths of supermassive stars. There is also suspected to be a supermassive black hole at the centre of our Milky Way galaxy.

**Comet** – A small solar system objects that orbits the sun and is made up of rock and ice. When a comet comes close to the sun in its orbit then it heats up and a tail is generated.

**Celestial object** – A term used to refer to an object in space such as a star, galaxy, planet, nebula or any other astronomical phenomena that is observable from Earth.

**Constellation** – An area of space containing a pattern of stars in the sky. This area is recognized internationally by a particular name. For example, the Hercules constellation is known

internationally as a particular area in the sky and contains a particular pattern of stars making up the figure of Hercules.

**Circumpolar constellation** – A constellation that does not set below the horizon. The set of circumpolar constellations you can see depends on your latitude.

**Deep sky object** – An object in the sky that is something other than an individual star and is not found within the solar system. For example, the Andromeda galaxy as well as the Orion nebula are both deep sky objects because they are found outside our solar system, and are not individual stars.

**Dwarf planet** – A solar system object that has significant mass but is not a planet. Pluto is considered to be a dwarf planet.

**Emission nebula** – A cloud of dust and gas that has a very high temperature and will absorb and re-emit light from a nearby star, causing the cloud to glow.

**Equator** – The imaginary line that goes around the midway point between the poles of the Earth. The equator is perpendicular to the rotation axis of the Earth.

**Finderscope** – The miniature scope on the side of a telescope that is used to make an initial alignment of an object that you want to observe. The finderscope is lined up parallel to the telescope. Once the object is lined up in the finderscope then it should also be visible through the eyepiece of your telescope.

**Galaxy** – A vast collection of stars, dust and gas all gravitationally bound and orbiting around a central point in space. We live within the Milky Way galaxy and the nearest galaxy to the Milky way is the Andromeda galaxy, located 2.5 million light years away.

**Interstellar** – The space between stars.

**Meteor** – A dust particle that is captured in Earth's atmosphere and burns up before it hits the ground. You will see a meteor as a streak across the sky.

**Meteor shower** – If the Earth passes through a significant amount of dust and gas left behind from a comet then there will be an increase in the number of visible meteors. Meteor showers are named after the constellation in which you will see the most meteors, for example the Orionids are found within the constellation Orion in late October.

**Meteorite** – A dust particle that is captured in Earth's atmosphere and is large enough that it does not burn up completely, causing it to reach the surface of the earth.



**Nebula** – An area of space that has a vast amount of dust and gas and is visible from Earth.

**Neutron star** – A dead and incredibly dense star that is left behind from a supernova explosion.

**Northern hemisphere** – Half of the planet that is north of the equator.

**Objective lens** – The main, large lens in a refracting telescope.

**Partial solar eclipse** – If you view a solar eclipse within the penumbra then you will witness a partial solar eclipse, only part of the sun will be blocked out by the moon.

**Partial lunar eclipse** – If the moon passes through the penumbra of Earth's shadow during a lunar eclipse then the eclipse will be partial.

**Penumbra** – Penumbra is used to describe the part of a shadow that will cause a partial eclipse to occur.

**Planet** – For something to be considered a planet it:

1. Must be orbiting the Sun.
2. Must be massive enough to be rounded by its own gravity (must be spherical like a ball).
3. Cannot be massive enough to burn like a star.
4. Must have cleared its orbit – so there can't be any large objects along its orbit.

**Planetary nebula** – A cloud of dust and gas that formed from the death of a star. The remaining material is hot enough to emit light, similar to an emission nebula.

**Primary mirror** – The main, large mirror in a reflecting telescope.

**Reflection nebula** – A cloud of dust and gas that reflects light from a nearby star, causing the cloud to glow.

**Satellite** – A celestial object like a moon that is orbiting another larger object. For example, Earth's moon is a satellite.

**Seasonal constellation** – A constellation that is only visible during certain months of the year.

**Secondary mirror** – The smaller mirror used to redirect the light within a reflecting telescope tube.

**Southern hemisphere** – Half of the Earth that is south of the equator.

**Small solar system object** – An object in the solar system that is not a planet, dwarf planet nor a satellite. This includes comets, asteroids and other relatively small objects orbiting the sun.

**Supernova** – If a star is massive enough it will die as a supernova explosion. The material contained in the star will collapse in on itself and spew out at incredible speeds as a supernova.

**Star** – A massive, spherical object that is held together by its own gravity. Stars come in all different sizes, colours and temperatures. Typical stars are burning hydrogen fuel in their cores. The sun for example is a mid-sized star and is steadily burning hydrogen fuel to provide warmth and light to the solar system.

**TELRAD** – Like a finderscope, a TELRAD is used to align celestial objects when observing with a telescope. The TELRAD is attached parallel to the telescope tube and when you look through it there will be a small laser target that you can use to do an initial alignment of an object that you want to observe.

**Umbra** – The part of a shadow that provides full darkness. If the moon falls within the umbra of Earth's shadow during a solar eclipse then the sun will be completely blocked out.

**White dwarf** – A very dense core of a dead star. These are found at the centres of planetary nebulae.







Saskatchewan

3830 Thatcher Avenue  
Saskatoon, Saskatchewan S7R 1A5  
306-933-7727 • 306-933-7730 (fax)  
[www.4-h.sk.ca](http://www.4-h.sk.ca) • [info@4-h.sk.ca](mailto:info@4-h.sk.ca)